

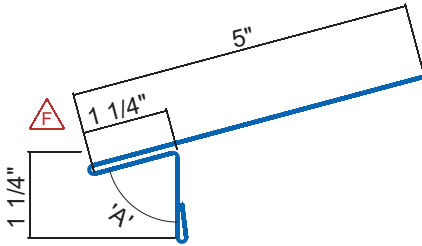

*Your Roof. For Life!
On Time and Complete!™*

Standing Seam Panel Flashings & Trims

EE01 For use with All Panels
4:12 PITCH STANDARD UNLESS
SPECIFIED OTHERWISE



Standard Extended Eave, 1-1/4" Face
For all slopes
Recommended to be use with gutters

EE02 For use with All Panels
4:12 PITCH STANDARD UNLESS
SPECIFIED OTHERWISE

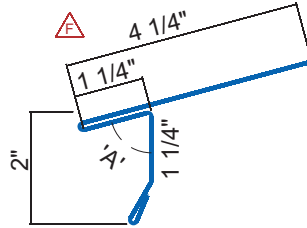

Standard Extended Eave, 2" Face
For slopes from 1:12 to 7:12

EE03 For use with All Panels
4:12 PITCH STANDARD UNLESS
SPECIFIED OTHERWISE

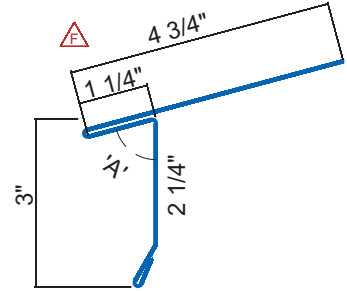

Standard Extended Eave, 3" Face
For slopes from 1:12 to 7:12

EE04 For use with All Panels
4:12 PITCH STANDARD UNLESS
SPECIFIED OTHERWISE

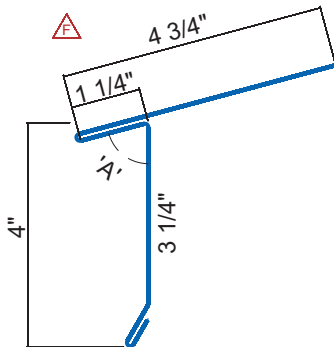

Standard Extended Eave, 4" Face
For slopes from 1:12 to 7:12

EE05 For use with All Panels
4:12 PITCH STANDARD UNLESS
SPECIFIED OTHERWISE

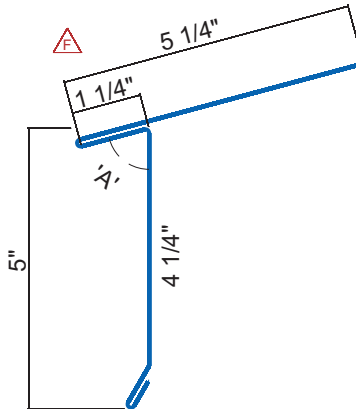

Standard Extended Eave, 5" Face
For slopes from 1:12 to 7:12

EE06
4:12 PITCH STANDARD UNLESS
SPECIFIED OTHERWISE

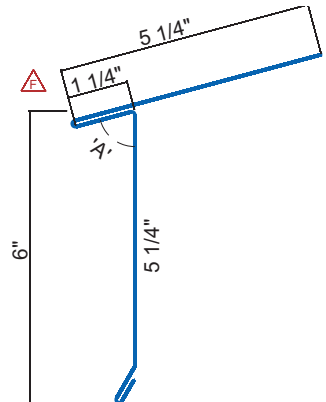

Standard Extended Eave, 6" Face
For slopes from 1:12 to 7:12

ES02 For use with All Panels
4:12 PITCH STANDARD UNLESS
SPECIFIED OTHERWISE

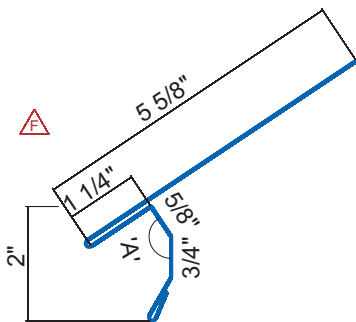

Steep Sloped Extended Eave, 2" Face
For slopes up to 12:12

ES03 For use with All Panels
4:12 PITCH STANDARD UNLESS
SPECIFIED OTHERWISE

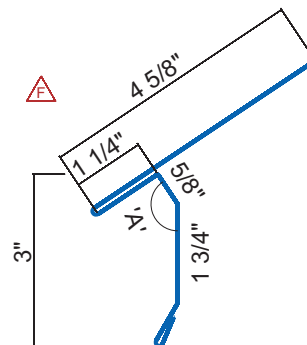

Steep Sloped Extended Eave, 3" Face
For slopes up to 12:12

ES04 For use with All Panels
4:12 PITCH STANDARD UNLESS
SPECIFIED OTHERWISE

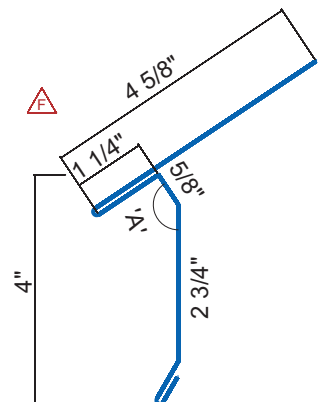

Standard Extended Eave, 3" Face
For slopes from 1:12 to 7:12

Standing Seam Panel Flashings & Trims



ES05 For use with All Panels
4:12 PITCH STANDARD UNLESS SPECIFIED OTHERWISE

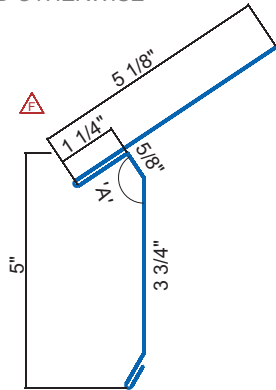

Steep Sloped Extended Eave, 5" Face
For slopes up to 12:12

ES06 For use with All Panels
4:12 PITCH STANDARD UNLESS SPECIFIED OTHERWISE

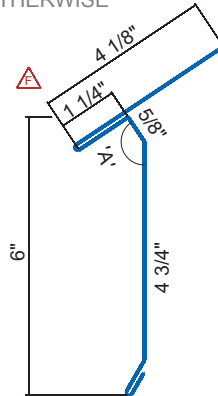

Steep Sloped Extended Eave, 6" Face
For slopes up to 12:12

EE12 For use with ML150 & ML200 Panels
4:12 PITCH STANDARD UNLESS SPECIFIED OTHERWISE

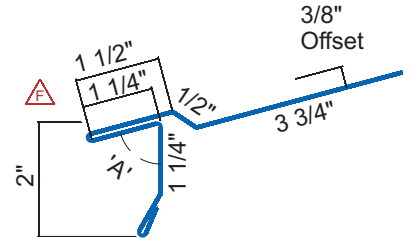

Extended Eave with Offset, 2" Face
For slopes from 1:12 to 7:12
For use with "stand-off" clip types

EE13 For use with ML150 & ML200 Panels
4:12 PITCH STANDARD UNLESS SPECIFIED OTHERWISE

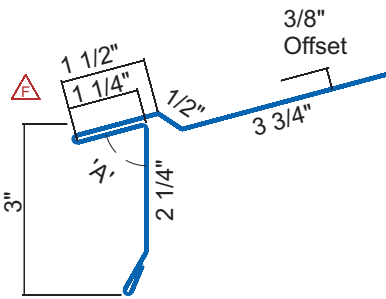

Extended Eave with Offset, 3" Face
For slopes from 1:12 to 7:12
For use with "stand-off" clip types

EE14 For use with ML150 & ML200 Panels
4:12 PITCH STANDARD UNLESS SPECIFIED OTHERWISE

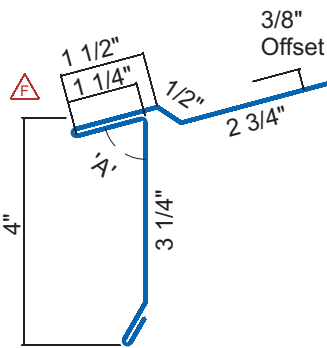

Extended Eave with Offset, 4" Face
For slopes from 1:12 to 7:12
For use with "stand-off" clip types

EE15 For use with ML150 & ML200 Panels
4:12 PITCH STANDARD UNLESS SPECIFIED OTHERWISE

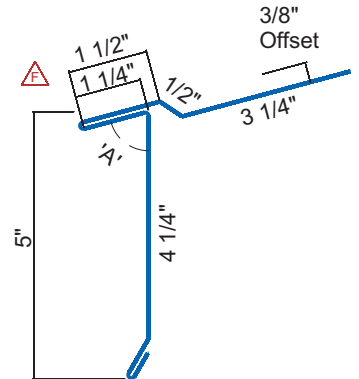

Extended Eave with Offset, 5" Face
For slopes from 1:12 to 7:12
For use with "stand-off" clip types

EE16 For use with ML150 & ML200 Panels
4:12 PITCH STANDARD UNLESS SPECIFIED OTHERWISE

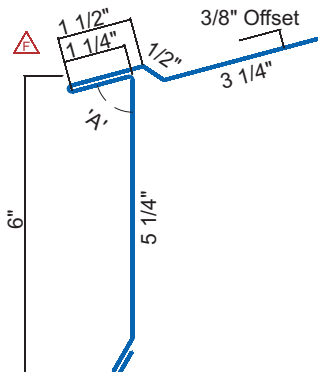

Extended Eave with Offset, 6" Face
For slopes from 1:12 to 7:12
For use with "stand-off" clip types

ES12 For use with ML150 & ML200 Panels
4:12 PITCH STANDARD UNLESS SPECIFIED OTHERWISE

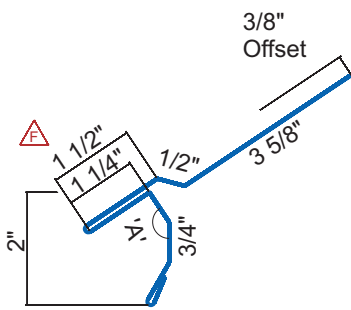

Steep Sloped Ext. Eave w/Offset, 2" Face
For slopes up to 12:12
For use with "stand-off" clip types

ES13 For use with ML150 & ML200 Panels
4:12 PITCH STANDARD UNLESS SPECIFIED OTHERWISE

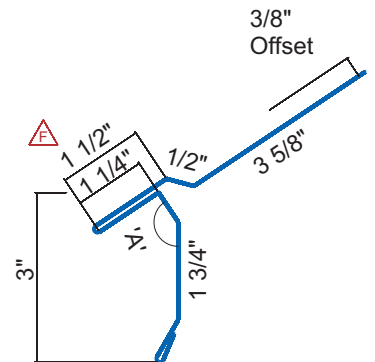

Steep Sloped Ext. Eave w/Offset, 3" Face
For slopes up to 12:12
For use with "stand-off" clip types

ES14 For use with ML150 & ML200 Panels
4:12 PITCH STANDARD UNLESS
SPECIFIED OTHERWISE

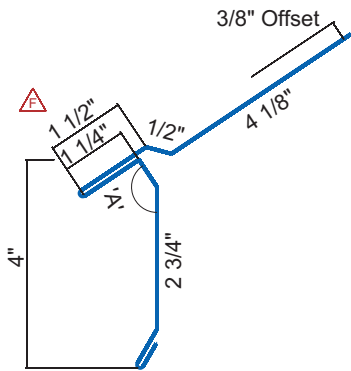

Steep Sloped Ext. Eave w/Offset, 4" Face
For slopes up to 12:12
For use with "stand-off" clip types

ES15 For use with ML150 & ML200 Panels
4:12 PITCH STANDARD UNLESS
SPECIFIED OTHERWISE

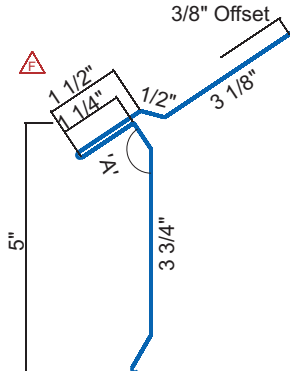

Steep Sloped Ext. Eave w/Offset, 5" Face
For slopes up to 12:12
For use with "stand-off" clip types

EE16 For use with ML150 & ML200 Panels
4:12 PITCH STANDARD UNLESS
SPECIFIED OTHERWISE

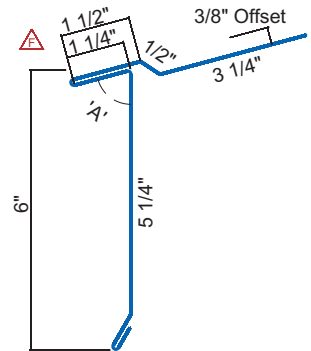

Steep Sloped Ext. Eave w/Offset, 6" Face
For slopes from 1:12 to 7:12
For use with "stand-off" clip types

ED02 For use with All Panels
4:12 PITCH STANDARD UNLESS
SPECIFIED OTHERWISE

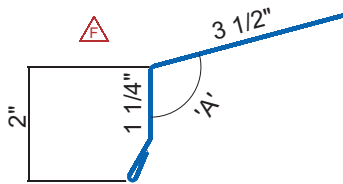

Eave Drip Edge, 2" Face
For all slopes

ED03 For use with All Panels
4:12 PITCH STANDARD UNLESS
SPECIFIED OTHERWISE

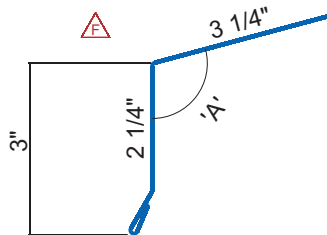

Eave Drip Edge, 3" Face
For all slopes

ED04 For use with All Panels
4:12 PITCH STANDARD UNLESS
SPECIFIED OTHERWISE



Eave Drip Edge, 4" Face
For all slopes

ED05 For use with All Panels
4:12 PITCH STANDARD UNLESS
SPECIFIED OTHERWISE

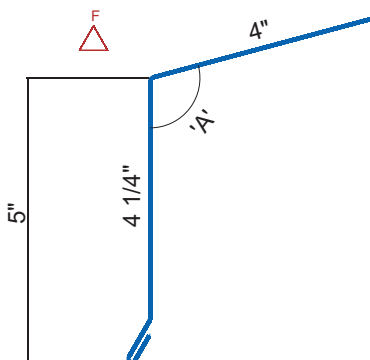

Eave Drip Edge, 5" Face
For all slopes

ED06 For use with All Panels
4:12 PITCH STANDARD UNLESS
SPECIFIED OTHERWISE

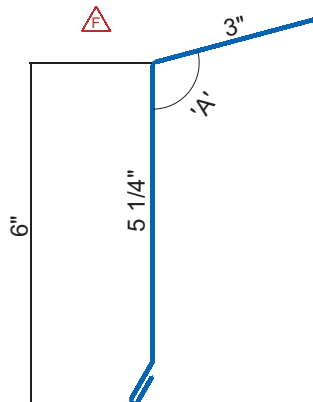

Eave Drip Edge, 6" Face
For all slopes

EG02 For use with All Panels

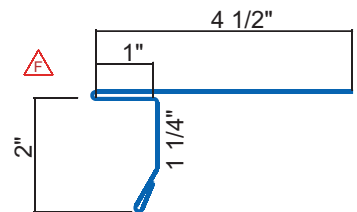

Extended Gable Trim, 2" Face

Standing Seam Panel Flashings & Trims



EG03

For use with
All Panels

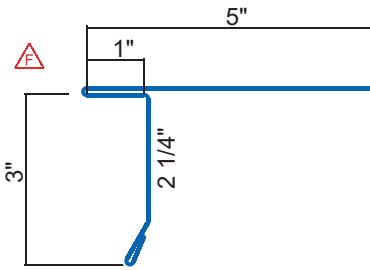

Extended Gable Trim, 3" Face

EG04

For use with
All Panels

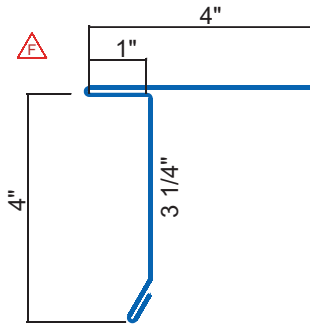

Extended Gable Trim, 4" Face

EG05

For use with
All Panels

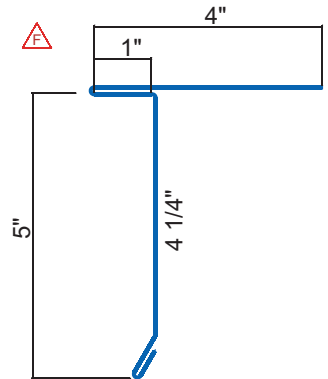

Extended Gable Trim, 5" Face

EG06

For use with
All Panels

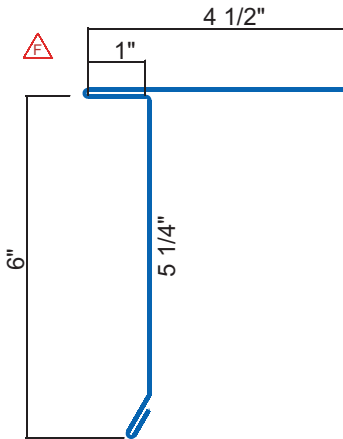

Extended Gable Trim, 6" Face

EG12

For use with
ML150 & ML200 Panels

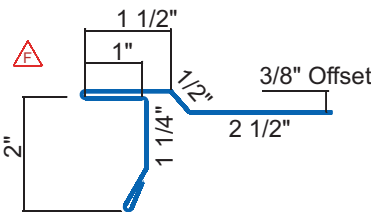

Extended Gable Trim w/Offset, 2" Face
For use with "stand-off" clip types

EG13

For use with
ML150 & ML200 Panels

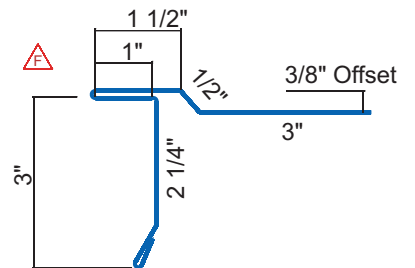

Extended Gable Trim w/Offset, 3" Face
For use with "stand-off" clip types

EG14

For use with
ML150 & ML200 Panels

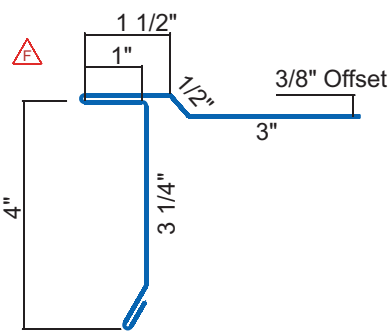

Extended Gable Trim w/Offset, 4" Face
For use with "stand-off" clip types

EG15

For use with
ML150 & ML200 Panels

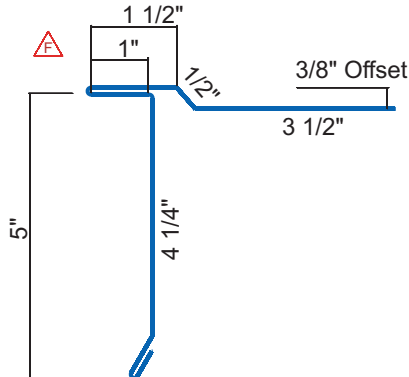

Extended Gable Trim w/Offset, 5" Face
For use with "stand-off" clip types

EG16

For use with
ML150 & ML200 Panels

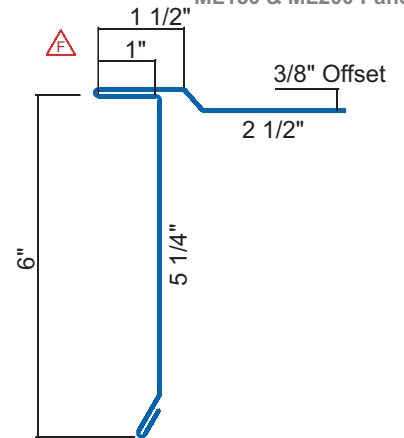

Extended Gable Trim w/Offset, 6" Face
For use with "stand-off" clip types

BG01

For use with
All Panels

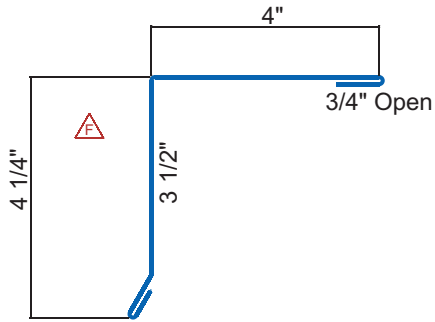

Box Gable Trim, 4-1/4" Face

BG02

For use with
All Panels

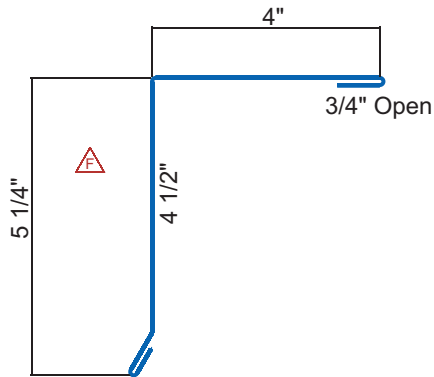

Box Gable Trim, 5-1/4" Face

BG03

For use with
All Panels

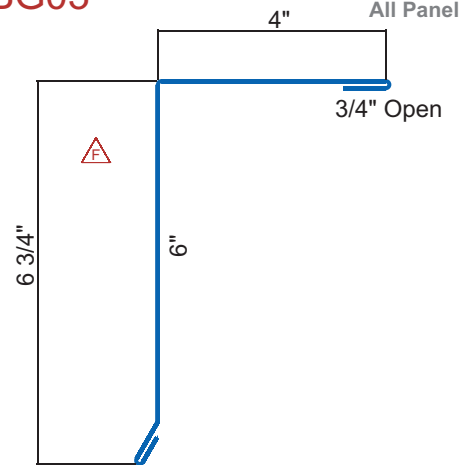

Box Gable Trim, 6-3/4" Face

BG11

For use with
SL150 & ML150 Panels

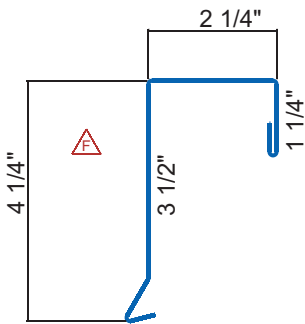

Box Gable Trim, 4-1/4" Face

BG12

For use with
SL150 & ML150 Panels

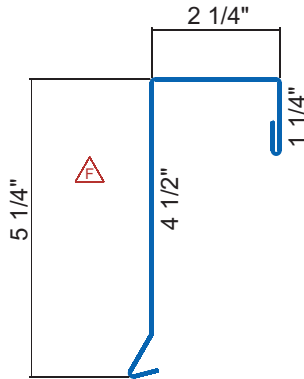

Box Gable Trim, 5-1/4" Face

BG13

For use with
SL150 & ML150 Panels

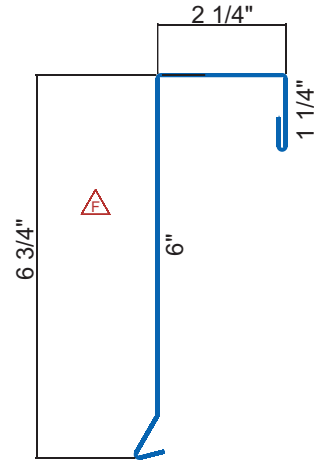

Box Gable Trim, 6-3/4" Face

BG21

For use with
SL175 Panel

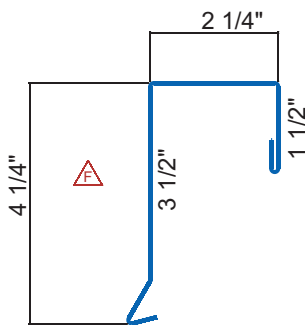

Box Gable Trim, 4-1/4" Face

BG22

For use with
SL175 Panel

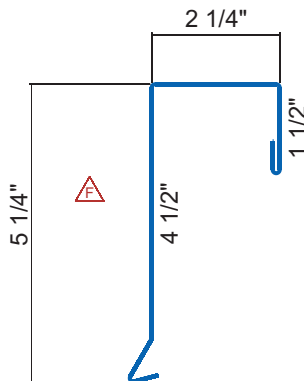

Box Gable Trim, 5-1/4" Face

BG23

For use with
SL175 Panel

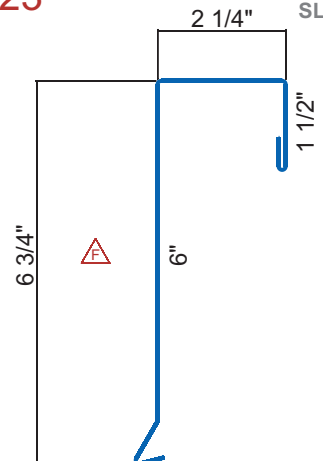

Box Gable Trim, 6-3/4" Face

Standing Seam Panel Flashings & Trims



BG31

For use with
ML200 Panel

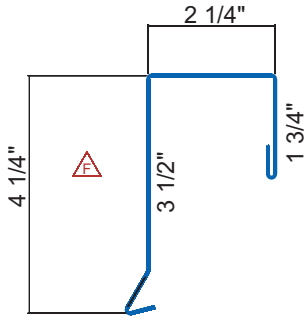

Box Gable Trim, 4-1/4" Face

BG32

For use with
ML200 Panel

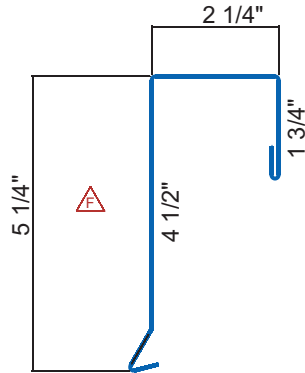

Box Gable Trim, 5-1/4" Face

BG33

For use with
ML200 Panel

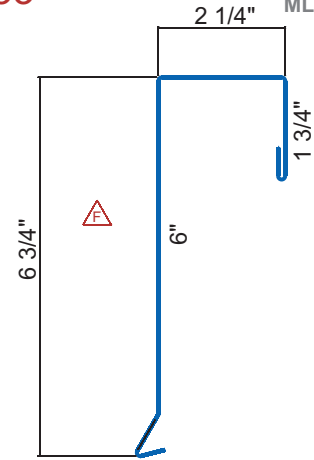

Box Gable Trim, 6-3/4" Face

SW01

For use with
All Panels

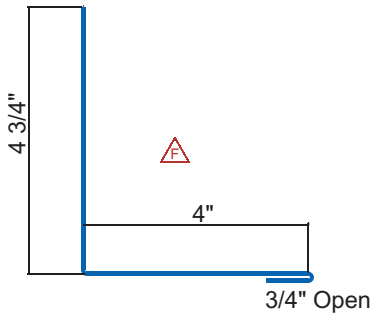

Sidewall Trim

SW02

For use with
All Panels

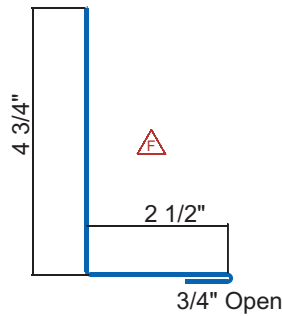

Sidewall Trim

SW10

For use with Slimline®

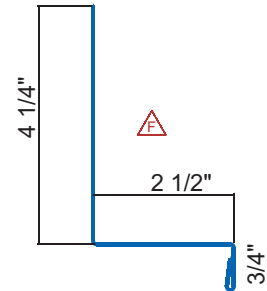

Sidewall Trim

SW11

For use with
SL150 & ML150 Panels

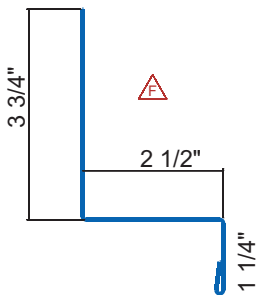

Sidewall Trim

SW12

For use with
SL175 Panel

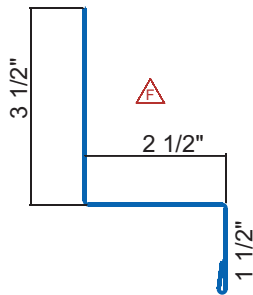

Sidewall Trim

SW13

For use with
ML200 Panel

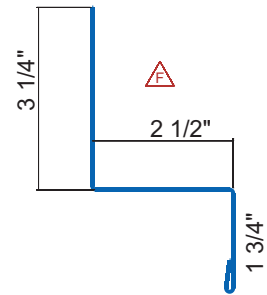

Sidewall Trim

HW01 For use with **All Panels**
4:12 PITCH STANDARD UNLESS
SPECIFIED OTHERWISE

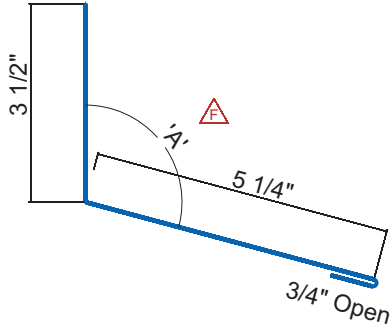

Highwall Trim

HW02 For use with **All Panels**
4:12 PITCH STANDARD UNLESS
SPECIFIED OTHERWISE

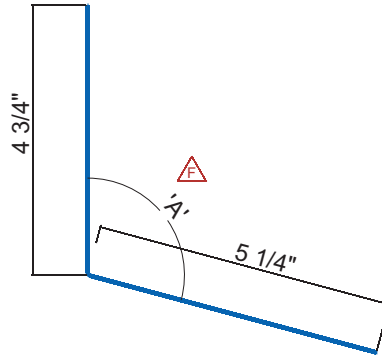

Highwall Trim

HW03 For use with **ML150 & ML200 Panels**
4:12 PITCH STANDARD UNLESS SPECIFIED
OTHERWISE

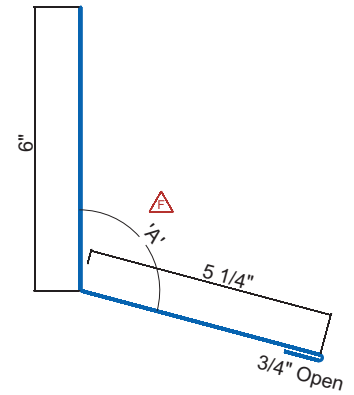

Highwall Trim

VH01 For use with **ML150 & ML200 Panels**
4:12 PITCH STANDARD UNLESS SPECIFIED
OTHERWISE

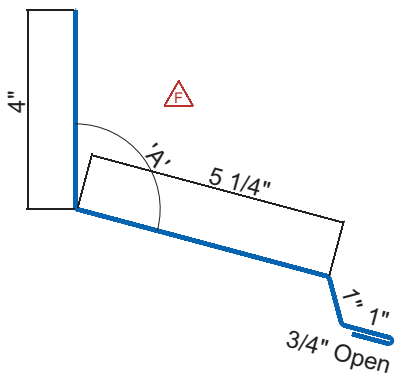

Vented Highwall Trim
Use with PC01 perforated vent cleat

VH02 For use with **ML150 & ML200 Panels**
4:12 PITCH STANDARD UNLESS SPECIFIED
OTHERWISE

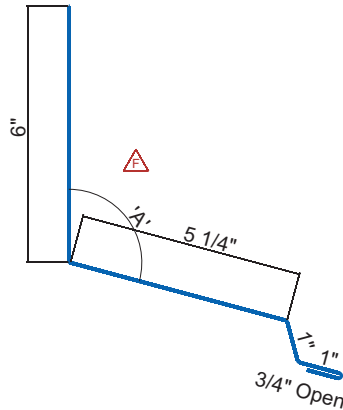

Vented Highwall Trim
Use with PC01 perforated vent cleat

Standing Seam Panel Flashings & Trims



ST01 For use with All Panels
4:12 PITCH STANDARD UNLESS
SPECIFIED OTHERWISE

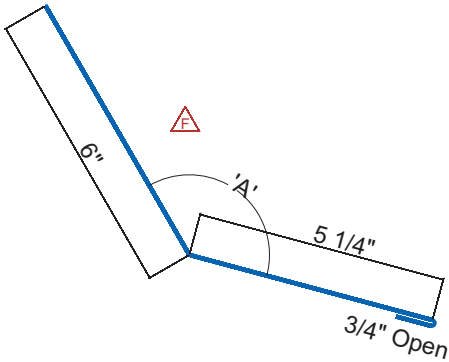

Slope Transition Flashing

ST02 For use with All Panels
4:12 PITCH STANDARD UNLESS
SPECIFIED OTHERWISE

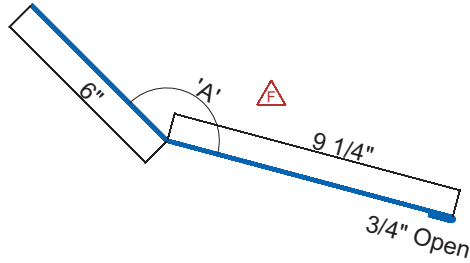

Slope Transition Flashing

LW01 For use with All Panels
4:12 PITCH STANDARD UNLESS
SPECIFIED OTHERWISE

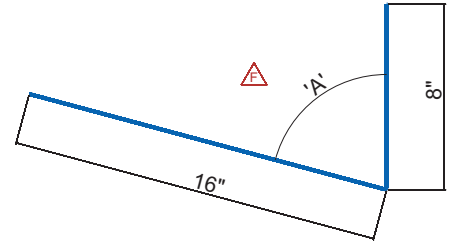

Low Wall Flashing

LW02 For use with All Panels
4:12 PITCH STANDARD UNLESS
SPECIFIED OTHERWISE

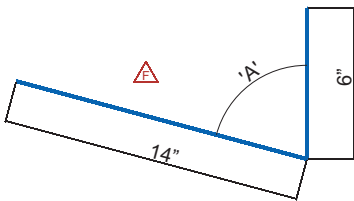

Low Wall Flashing

GM01 For use with All Panels
4:12 PITCH STANDARD UNLESS
SPECIFIED OTHERWISE

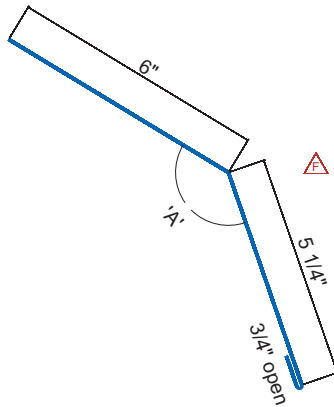

Gambrel Flashing

TF01 For use with All Panels

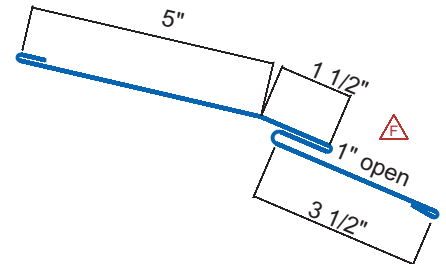

Vented Highwall Trim
For low ends of panels
over membrane roofing

VB1A thru VB1G

For use with **All Panels**
4:12 PITCH STANDARD UNLESS
SPECIFIED OTHERWISE

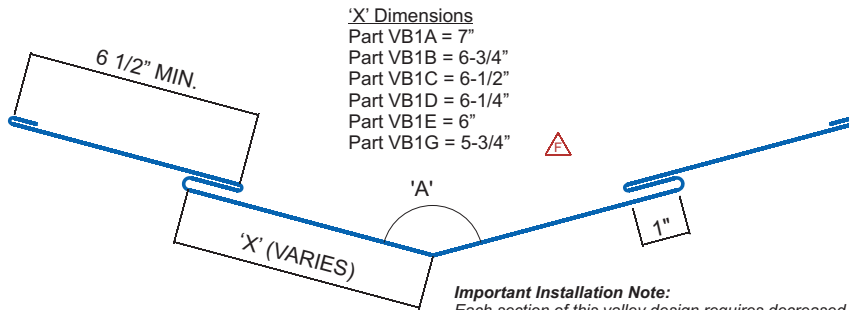

Important Installation Note:
 Each section of this valley design requires decreased widths of exposed portion ('X') of valley. This is to allow for each upper section to be lapped over the lower section. The first valley section to be installed at the lowest point should be Section 'A' and then proceeding with 'B', 'C', ... Exposed valley dimension will be reduced by 1/4" on each side for each section progressing up slope.

Valley with Built-In Cleat

For use with all standing seam panel types

VA01

For use with **All Panels**
4:12 PITCH STANDARD UNLESS
SPECIFIED OTHERWISE

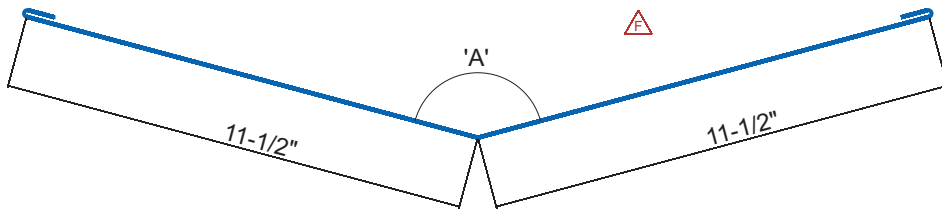

Valley Flashing

WV01

For use with **All Panels**
4:12 PITCH STANDARD UNLESS
SPECIFIED OTHERWISE

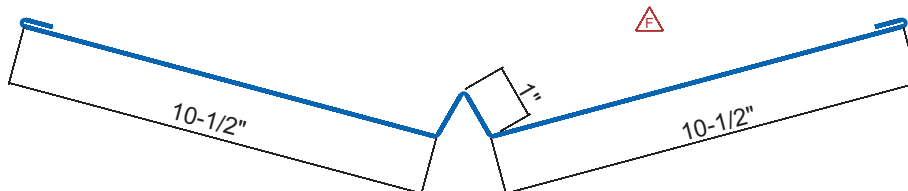

W-Valley Flashing

RC05

For use with **All Panels**
4:12 PITCH STANDARD UNLESS
SPECIFIED OTHERWISE

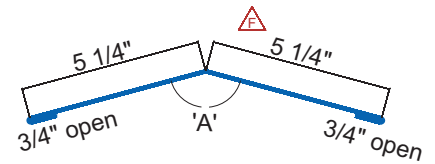

Ridge Flashing

Use for slopes up to 5:12

RC06

For use with **All Panels**
4:12 PITCH STANDARD UNLESS
SPECIFIED OTHERWISE

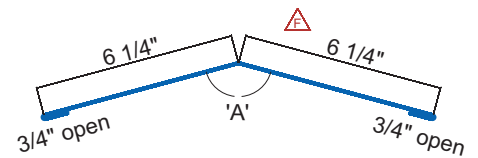

Ridge Flashing

Use for slopes up to 9:12

RC07

For use with **All Panels**
4:12 PITCH STANDARD UNLESS
SPECIFIED OTHERWISE

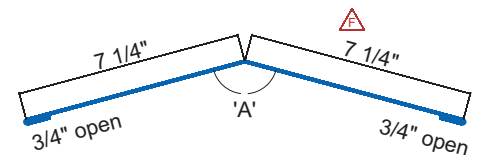

Ridge Flashing

Use for slopes up to 12:12

Standing Seam Panel Flashings & Trims



VR07 For use with **All Panels**
4:12 PITCH STANDARD UNLESS SPECIFIED OTHERWISE

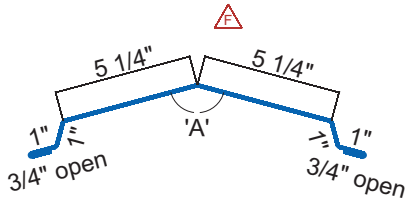

Vented Ridge Flashing
Use for slopes up to 5:12

VR08 For use with **All Panels**
4:12 PITCH STANDARD UNLESS SPECIFIED OTHERWISE

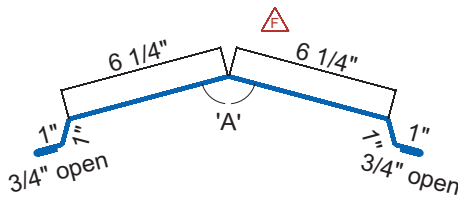

Vented Ridge Flashing
Use for slopes up to 9:12

VR09 For use with **All Panels**
4:12 PITCH STANDARD UNLESS SPECIFIED OTHERWISE

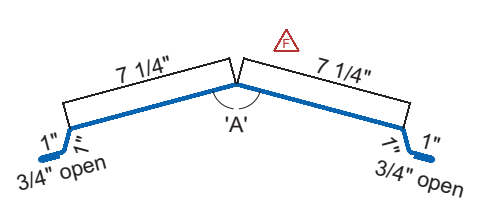

Vented Ridge Flashing
Use for slopes up to 12:12

HP05 For use with **All Panels**
4:12 PITCH STANDARD UNLESS SPECIFIED OTHERWISE

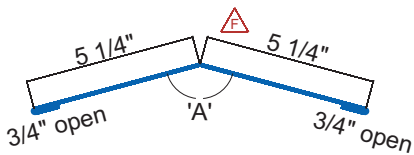

Hip Flashing
Use for slopes up to 5:12

HP06 For use with **All Panels**
4:12 PITCH STANDARD UNLESS SPECIFIED OTHERWISE

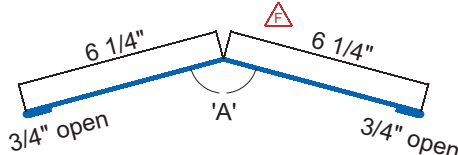

Hip Flashing
Use for slopes up to 9:12

HP07 For use with **All Panels**
4:12 PITCH STANDARD UNLESS SPECIFIED OTHERWISE

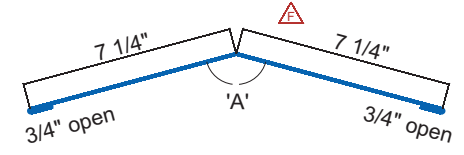

Hip Flashing
Use for slopes up to 12:12

PK55 For use with **All Panels**
4:12 PITCH STANDARD UNLESS SPECIFIED OTHERWISE

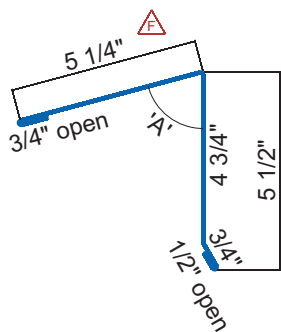

Peak Flashing
Use with PC55 cleat

PK75 For use with **All Panels**
4:12 PITCH STANDARD UNLESS SPECIFIED OTHERWISE

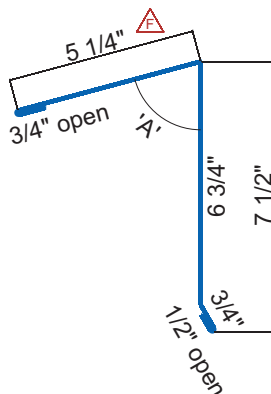

Peak Flashing
Use with PC72 cleat

PV85 For use with **All Panels**
4:12 PITCH STANDARD UNLESS SPECIFIED OTHERWISE

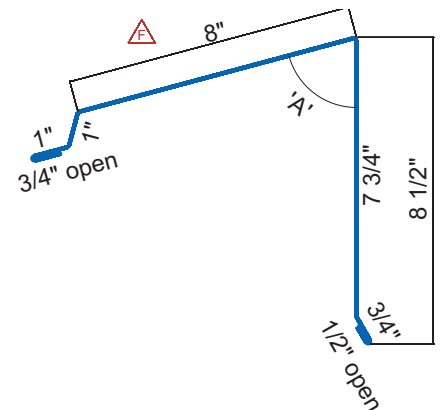

Vented Peak Flashing
Use with PC01 perforated vent cleat

CL01

For use with
All Panels

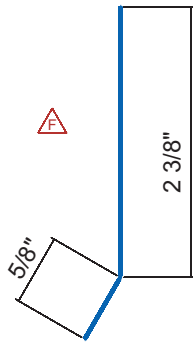

Cleat

OC01

For use with
All Panels

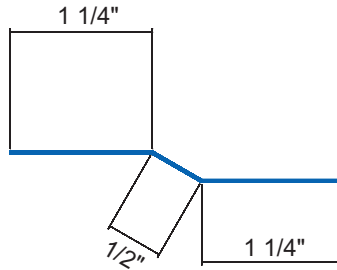

Offset Cleat

JC01

For use with
All Panels

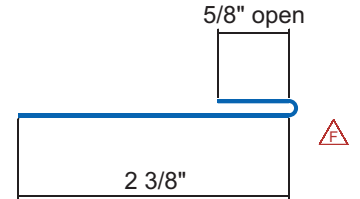

J-Cleat

JC02

For use with
All Panels

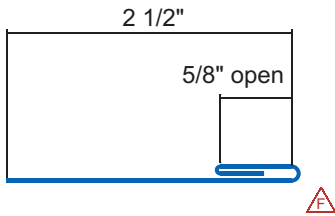

J-Cleat with Hem

PC01

For use with
All Panels

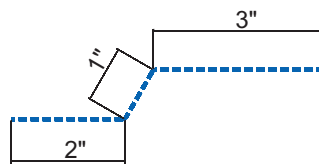

Perforated Vent Cleat (20 gauge)

FC01

For use with
All Panels

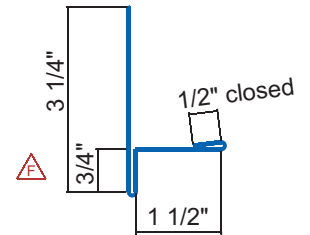

Fascia Cleat with Soffit Return

FC02

For use with
All Panels

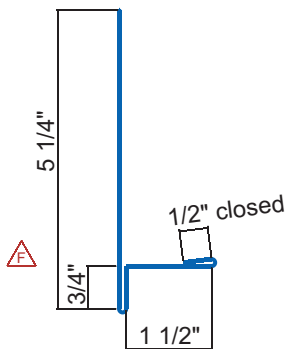

Fascia Cleat with Soffit Return

FC03

For use with
All Panels

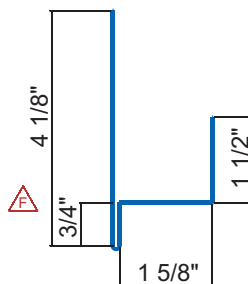

Fascia Cleat with 2x Return

PC55

4:12 PITCH STANDARD
UNLESS SPECIFIED OTHERWISE

For use with
All Panels

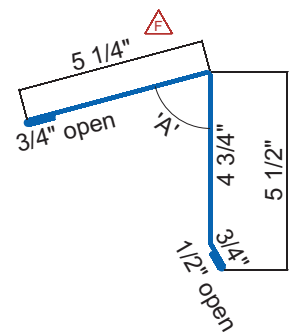

Peak Cleat
Use with PK55

Standing Seam Panel Flashings & Trims



PC75

4:12 PITCH STANDARD
UNLESS SPECIFIED OTHERWISE

For use with
All Panels

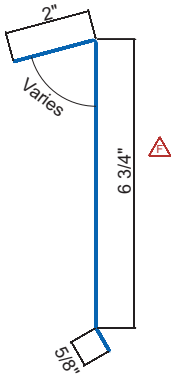

Peak Cleat
Use with PK75

PC85

4:12 PITCH STANDARD
UNLESS SPECIFIED OTHERWISE

For use with
All Panels

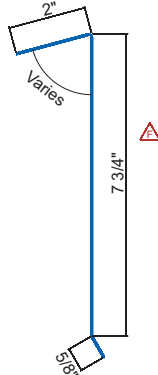

Peak Cleat
Use with PK85

ZE11

For use with Slimline®

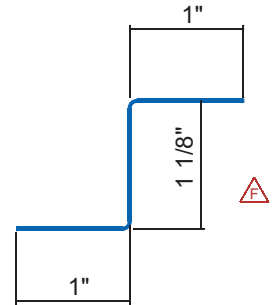

Zee Closure, 1-1/8" Tall

ZE16

For use with
SL150 & ML150 Panels

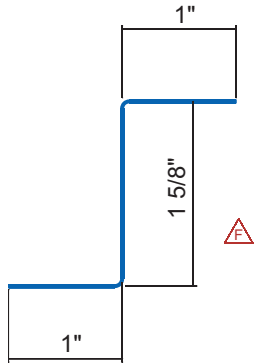

Zee Closure, 1-5/8" Tall

ZE18

For use with
SL175 Panel

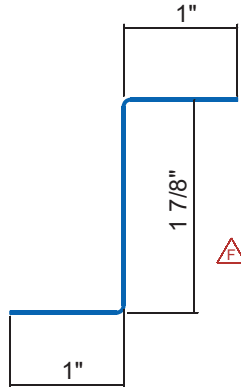

Zee Closure, 1-7/8" Tall

ZE21

For use with
ML200 Panel

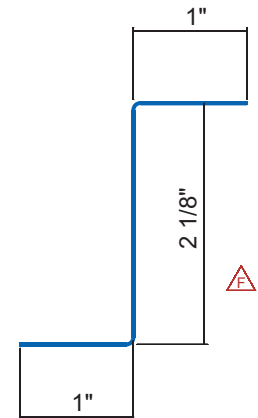

Zee Closure, 2-1/8" Tall

SJ12

For use with
Slimline®

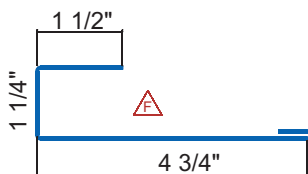

J-Channel, 1-1/4"

SJ17

For use with
SL150 & ML150 Panels

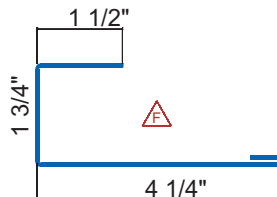

J-Channel, 1-3/4"

SJ20

For use with
SL175 Panel

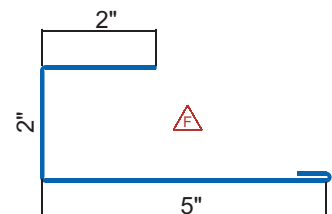

J-Channel, 2"

SJ22

For use with
ML200 Panel

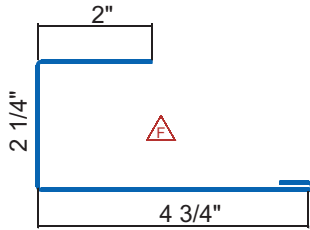

J-Channel, 2-1/4"

SJ2X

For use with
ML200 Panel

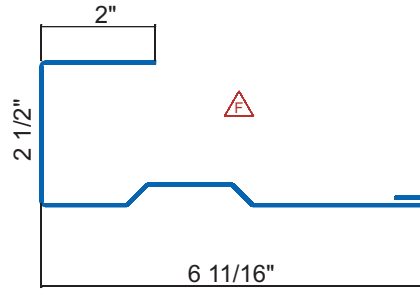

ML200 J-Channel Sub-Flashing
For use with "stand-off" clip types

SA2X

For use with
ML200 Panel

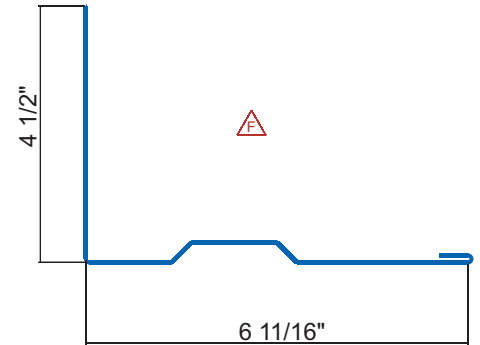

ML200 Sub-Flashing Angle
For use with "stand-off" clip types

SA01

For use with
All Panels

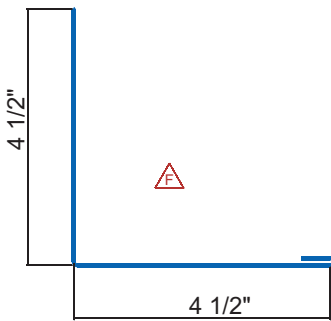

Sub-Flashing Angle

FG01

For use with
All Panels

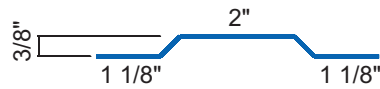

3/8" Sub-Furring

FG02

For use with
All Panels

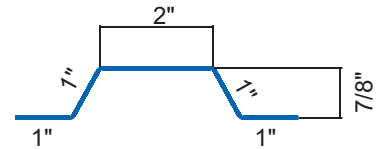

7/8" Sub-Furring

SJ1X

For use with
ML150 Panel

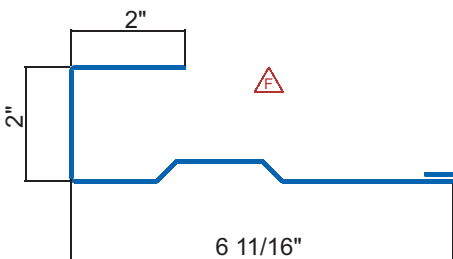

ML150 J-Channel Sub-Flashing

JC10

For use with
FL100 Panel

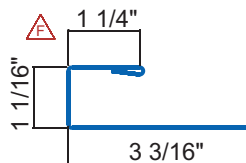

J-Channel for FL100 Panel

DJ10

For use with
FL100 Panel

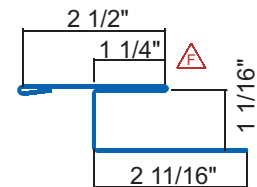

Double J-Channel for FL100 Panel

Standing Seam Panel Flashings & Trims



JC12

For use with Slimline®

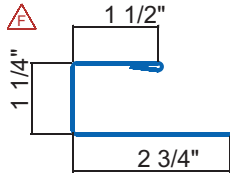

J-Channel, 1-1/4"

JC17

For use with SL150 & ML150 Panels

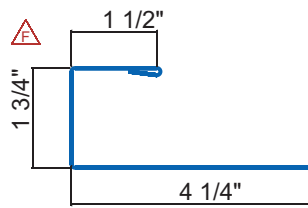

J-Channel, 1-3/4"

JC20

For use with All Panels

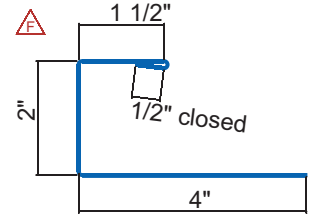

J-CHANNEL, 2"

J-Channel, 1-3/4"

JC22

For use with ML200 Panel

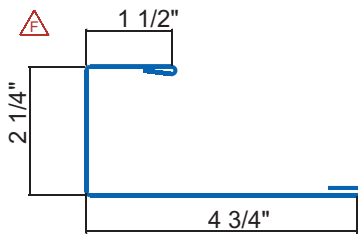

J-CHANNEL, 2-1/4"

J-Channel, 2-1/4"

SM67

For use with All Panels

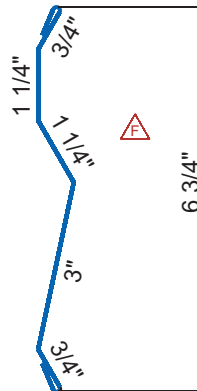

Surface Mounted Counter Flashing

SM55

For use with All Panels

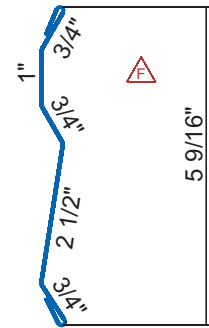

Surface Mounted Counter Flashing

RF25

For use with All Panels

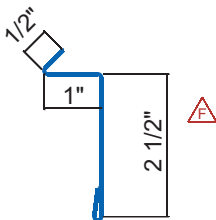

Reglet Flashing

RF40

For use with All Panels

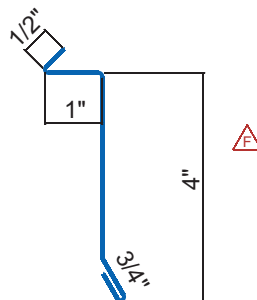

Reglet Flashing

RF60

For use with All Panels

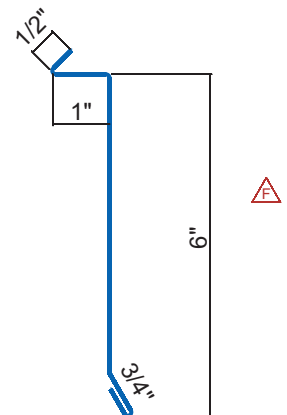

Reglet Flashing

FA01

For use with
All Panels

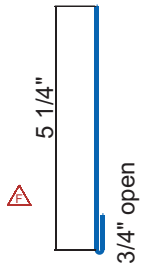

Fascia Cover, 5-1/4"
Use with FC## fascia cleat

FA02

For use with
All Panels

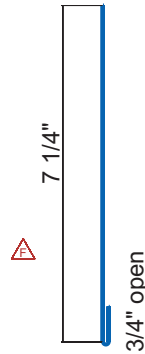

Fascia Cover, 7-1/4"
Use with FC## fascia cleat

FA03

For use with
All Panels

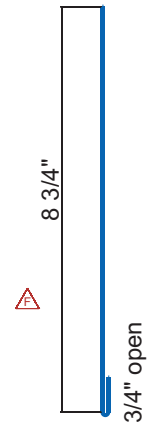

Fascia Cover, 8-3/4"
Use with FC## fascia cleat

FA04

For use with
All Panels

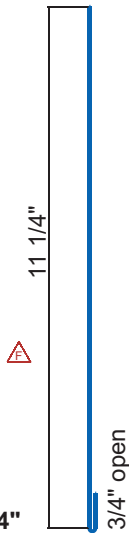

Fascia Cover, 11-1/4"
Use with FC## fascia cleat

FA10

For use with
All Panels

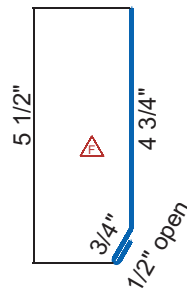

Fascia Cover, 5-1/2" w/ kickout
Use with CL01 cleat

FA11

For use with
All Panels

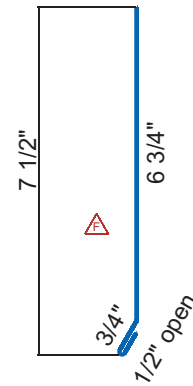

Fascia Cover, 7-1/2" w/ kickout
Use with CL01 cleat

FA12

For use with
All Panels

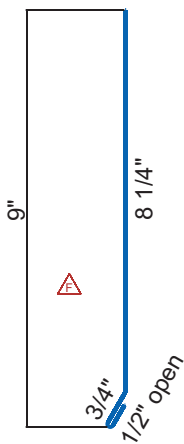

Fascia Cover, 9" w/ kickout
Use with CL01 cleat

FA13

For use with
All Panels

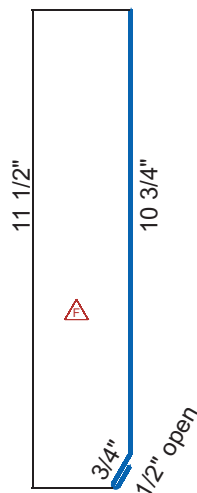

Fascia Cover, 11-1/2" w/ kickout
Use with CL01 cleat

FA20

For use with
All Panels

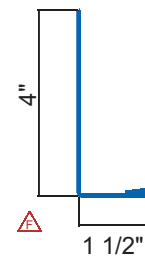

Fascia Cover, 4" L-shaped

Standing Seam Panel Flashings & Trims



FA21

For use with
All Panels

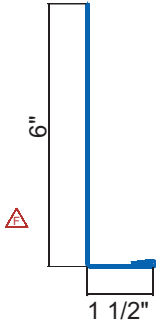

Fascia Cover, 6" L-shaped

FA22

For use with
All Panels

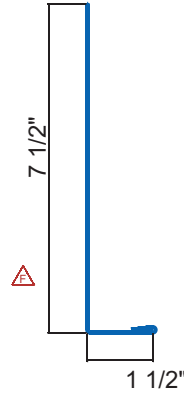

Fascia Cover, 7-1/2" L-shaped

FA23

For use with
All Panels

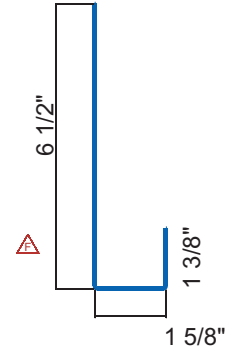

Fascia Cover, 6-1/2" J-shaped

FA24

For use with
All Panels

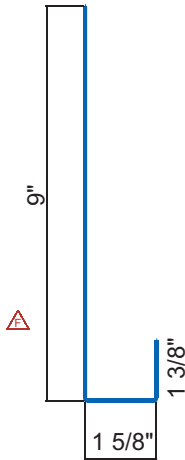

Fascia Cover, 9" L-shaped

SL01

For use with
FL100 & Slimline®

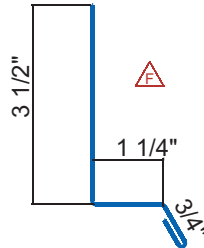

Sill Trim, 1-1/4"

SL02

For use with
SL150 & ML150 Panels

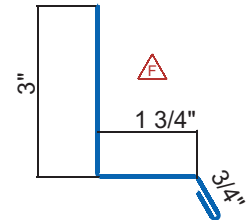

Sill Trim, 1-3/4"

SL03

For use with
SL175 Panel

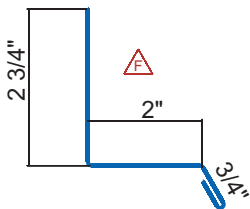

Sill Trim, 2"

SL04

For use with
ML200 Panel

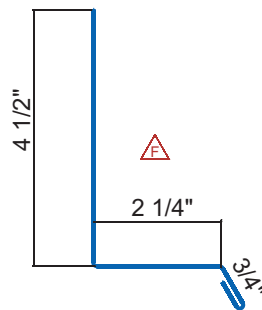

Sill Trim, 2-1/4"

SL10

For use with
FL100 & Slimline® Panels

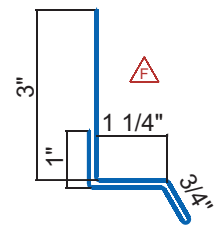

Sill Trim, 1-1/4"

SL11 For use with SL150 & ML150 Panels

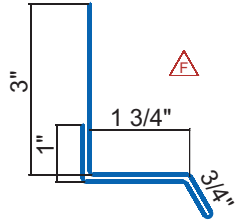

Sill Trim, 1-3/4"

SL12 For use with SL175 Panel

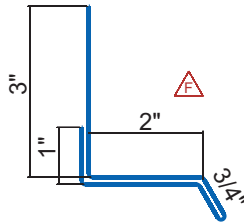

Sill Trim, 2"

SL13 For use with ML200 Panel

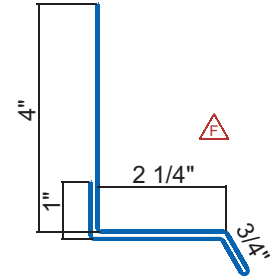

Sill Trim, 2-1/4"

SL20 For use with FL100 & Slimline® Panels

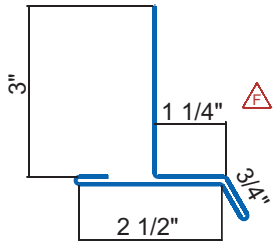

Sill Trim, 1-1/4"

SL21 For use with SL150 & ML150 Panels

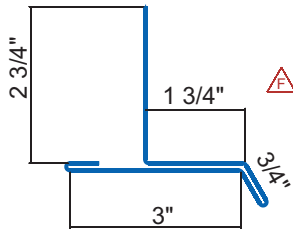

Sill Trim, 1-3/4"

SL22 For use with SL175 Panel

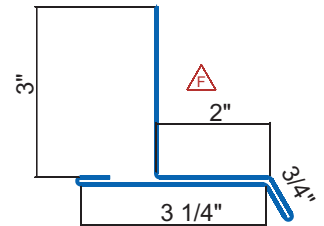

Sill Trim, 2"

SL23 For use with ML200 Panel

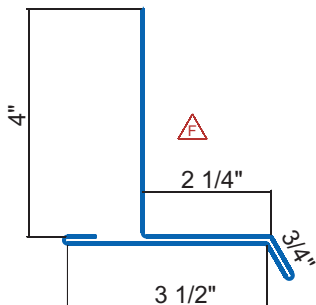

Sill Trim, 2-1/4"

CN01 For use with All Panels

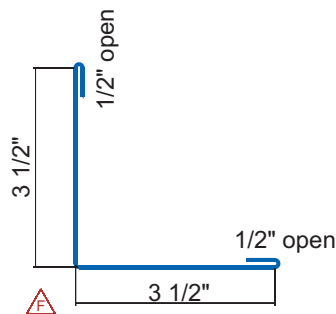

Outside Corner

CN02 For use with All Panels

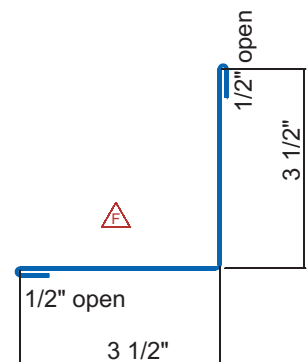

Inside Corner

Standing Seam Panel Flashings & Trims



EJ10

For use with Slimline®

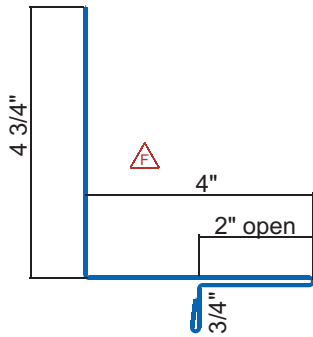

Sidewall Expansion Joint Flashing

EJ11

For use with SL150 & ML150 Panels

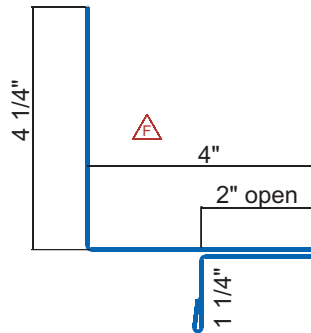

Sidewall Expansion Joint Flashing

EJ12

For use with SL175 Panel

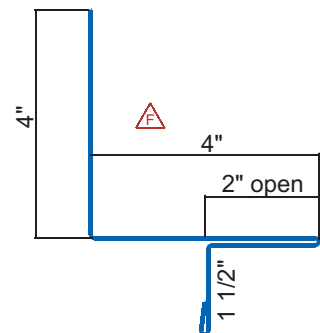

Sidewall Expansion Joint Flashing

EJ13

For use with ML200 Panel

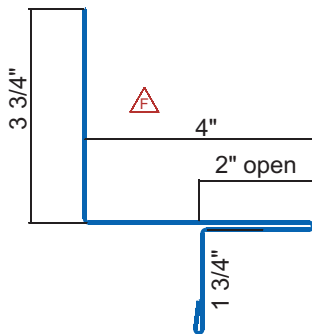

Sidewall Expansion Joint Flashing

EJ20

For use with Slimline®

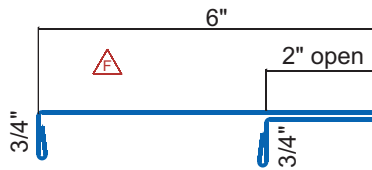

Mid-Roof Expansion Joint Flashing

EJ21

For use with SL150 & ML150 Panels

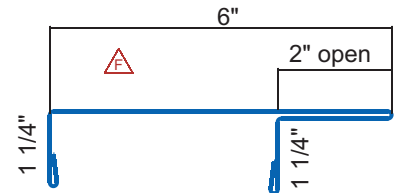

Mid-Roof Expansion Joint Flashing

EJ22

For use with SL175 Panel

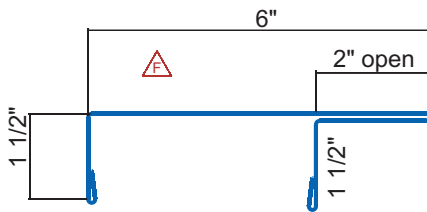

Sidewall Expansion Joint Flashing

EJ23

For use with ML200 Panel

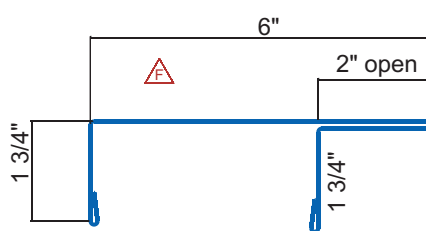

Sidewall Expansion Joint Flashing

DX01

For use with All Panels

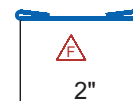

Downspout Strapping

GT05

For use with
All Panels

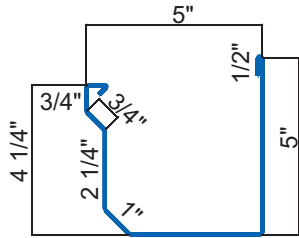

Gutter, 5" Style D Straight Back

GT06

For use with
All Panels

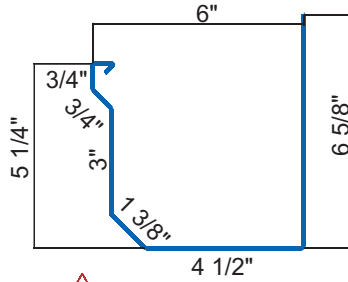

Gutter, 6" Style D Straight Back

GT07

For use with
All Panels

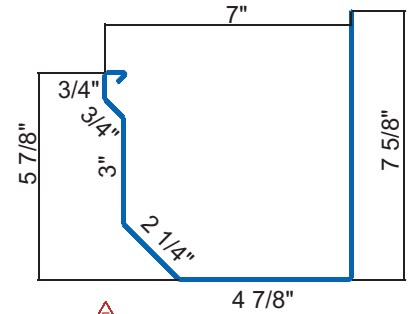

Gutter, 7" Style D Straight Back

GT08

For use with
All Panels

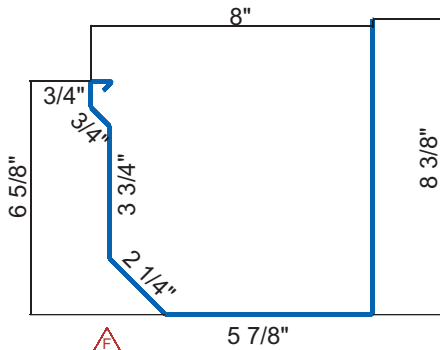

Gutter, 8" Style D Straight Back

GT15

For use with
All Panels

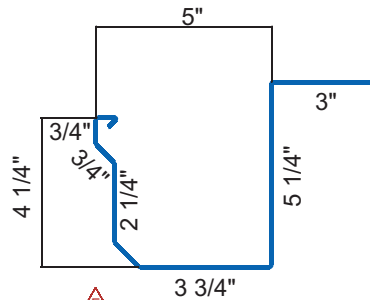

Gutter, 5" Style D Flanged Back

GT16

For use with
All Panels

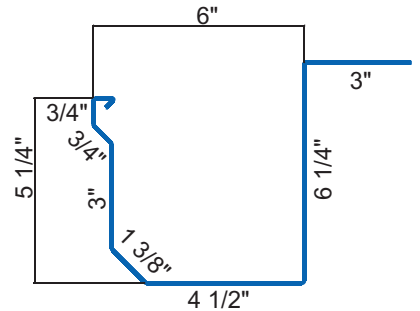

Gutter, 6" Style D Flanged Back

GT17

For use with
All Panels

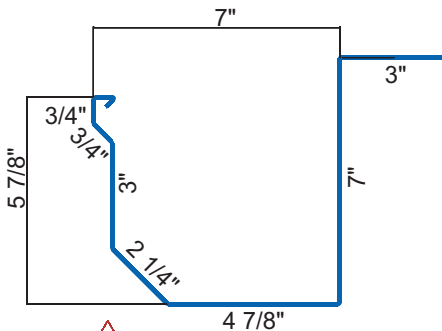

Gutter, Style D Flanged Back

GT18

For use with
All Panels

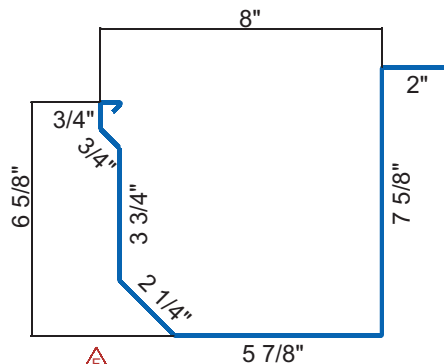

Gutter, Style D Flanged Back

DS

'A' x 'B' Dimensions

- Part DS34 = 3" x 4"
- Part DS35 = 3-1/2" x 4"
- Part DS44 = 4" x 4"
- Part DS45 = 4" x 5"
- Part DS46 = 4" x 6"
- Part DS55 = 5" x 5"
- Part DS56 = 5" x 6"

For use with
All Panels

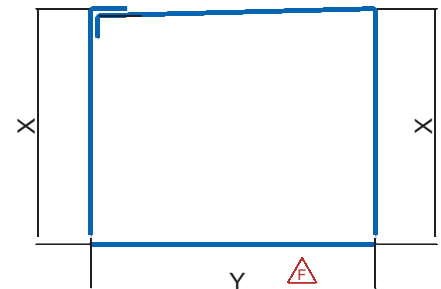

Downspout, Smooth Rectangular