



*Your Roof. For Life!
On Time and Complete!™*

Advantage-Lok II

Standing Seam Roof System

Product Manual

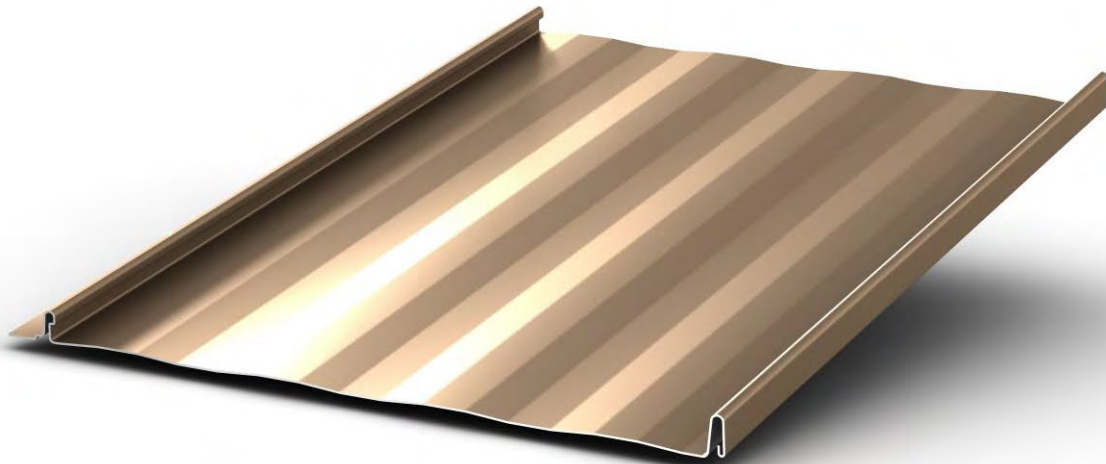

Table of Contents

1. General Information	4
a. Notice	
b. Applicability	
c. Safety	
d. Material Handling and Storage	
e. Packaging	
f. Unloading	
g. Handling	
h. Storage	
2. Working With Metal	6
a. Cutting and Drilling	
b. Expansion and Contraction	
c. Oil-Canning	
d. Dissimilar Metals	
e. Chemically Treated Lumber	
f. Graphite	
3. Design Information	8
a. Planning	
b. Slope	
c. Substrate	
d. Underlayment	
e. Insulation, Vapor Retarders, & Air Barriers	
f. Ventilation	
4. Product Information	10
a. Advantage-Lok II Panel Description and Options	
b. Panel Fasteners	
c. Sealants	
d. Metal Flashings and Trim	
5. Installation Instructions	14
a. Tools and Accessories	
b. Underlayment Installation	
c. Advantage-Lok II Panel Installation	
d. Installing Trim and Flashing Details	
6. Roof Protection and Repair	20
a. Roof Protection During Installation	
b. Roof Protection After Installation	
c. Finishes and Touchup	
d. Repairs to Roof	
Appendix	
I. Accessories Guide	21-22
II. Flashings and Trim	23-27
III. Installation Details	
a. Advantage-LokII Details Cover Sheet.....	28
b. Eave Detail (up to 7:12 slope).....	29
c. Eave Detail (steep slope).....	29
d. Eave Detail (flush style).....	30
e. Eave Detail (with gutter).....	30
f. Gable Detail (extended drip edge style).....	31
g. Gable Detail (box style with zee closure).....	31
h. Valley Detail.....	32
i. Ridge and Hip Detail.....	32
j. Vented Ridge Detail (with perforated cleat).....	33
k. Vented Ridge Detail (with perforated zee closure).....	33

l. Peak Detail	34
m. Highwall (Endwall) Detail	34
n. Low Wall Detail	35
o. Sidewall Detail	35
p. Slope Transition Detail	36
q. Gambrel Detail	36
r. Pipe Penetration Detail	37
s. Curb Detail Series	38 thru 40

1. GENERAL INFORMATION

a. Notice

- This guide contains general design guidance and suggested application instructions and details for proper application of Union Corrugating Company (UCC) metal roofing products. It is the responsibility of the installer to verify conformance of installation to applicable building code, safety, and insurance requirements. UCC assumes no responsibility for any problems which might arise as a result of improper installation or any personal injury or property damage that may occur with the product's use.
- Statements in this guide are provided in good faith with the expectation that a design professional be consulted prior to any job decisions being made. Projects should be engineered to conform to applicable building codes, regulations, and accepted industry practices.
- Installing a metal roofing system is a skilled craft that requires considerable trade knowledge and experience. It is not the intent of this guide or UCC to train individuals in the skills required to properly install a metal roof system or to convey all the necessary trade or general construction knowledge required to properly and safely perform work on a roof. UCC does not guarantee and is not liable for the qualifications of the installer.
 - For additional information and resources pertaining to the installation of metal roofing materials, the following sources are recommended:
 - a. SMACNA (Sheet Metal and Air Conditioning Contractors' National Association) Architectural Sheet Metal Manual. (www.smacna.org)
 - b. The NRCA (National Roofing Contractors Association) Roofing Manual: Metal Panel and SPF Roof Systems. (www.nrca.net)
- It is the responsibility of the UCC customer, installer, and/or designer to ensure that the details meet particular building requirements to assure weathertightness.
- This guide is intended to be used in conjunction with engineered shop drawings specific to an individual project (if applicable). Custom roof conditions and detailing are covered by engineered shop drawings for the specific project. In the event of a conflict between this guide and the engineered shop drawings, the engineered shop drawings will take precedence.
- Contents in this guide are subject to change and revision without notice. Please contact UCC to verify that this manual is the most current copy available.

b. Applicability

- The Advantage-Lok II metal roof system as described within this manual is classified as an architectural, non-structural, standing seam metal roof panel. The Advantage-Lok II panel is mechanically attached with hidden fasteners to a continuous solid substrate with an underlayment. The detailing and attachment methods described within this manual best reflect "steep sloped" sheet metal joinery considered a craft or trade. This type of detailing, with clean lines and hidden fasteners is desired for high performance in combination with visual appeal.

c. Safety

- There are potential hazards associated with the installation of a metal roof system. An experienced installer should recognize these hazards, be qualified to work with them, and be capable of providing safe work practices and equipment that minimize the risks of injury. Following are some warnings that should be considered when working with metal roofing. These may not cover all hazards, so the installer should take proper precaution to be prepared for working on roofs and handling metal.
 - OSHA (Occupational Safety and Health Administration): Obey OSHA regulations, particularly those related to roof construction, such as Title 29 Code of Federal, 1926 Subpart M, Fall Protection. For copies of OSHA regulations visit www.osha.gov.
 - Use fall protection and all appropriate safety equipment as agencies or jobsites require.
 - Avoid working on surfaces that are covered with moisture, frost, snow/ice, dust or other substance that may cause unsure footing.
 - Never walk on substrate, underlayment, or panels that are not properly secured in place.
 - Take caution when handling sheet metal panels and flashings. Edges can be sharp and can cause severe cuts. Wear heavy gloves for protection.
 - Wear eye protection when cutting and drilling to prevent eye injury from flying metal fragments.
 - Take caution when handling panels and trim in strong winds. Wind pressure can cause loss of balance and endanger workers with being struck by flying objects.

- Materials loaded to rooftop should always be secured to substrate to prevent them from sliding down roof slope or being dislodged by high winds.
 - Maintain safe distances from electric power lines when handling metal panels and trims since they are excellent conductors.
- d. Material Handling and Storage
- Receiving a delivery
 - When receiving materials, check the condition of the product and review the shipment against the shipping ticket to ensure all items are accounted for. If damages or shortages are discovered, it should be noted on the shipping copy at the time of delivery. UCC will not be responsible for shortages or damages unless they are noted on the shipping ticket. In addition, all damages and shortages should be reported to UCC with 48 hours from time of shipment.
- e. Packaging
- Advantage-Lok II panels are shipped in bundled units of approximately fifty panels. Panels are stacked on edge and are packaged with wood blocking in an open crate design. Space is provided under crates for access by forks of lift truck or inserting lifting slings/straps when offloading by crane (*Figure 1*).
 - For LTL or special overseas shipments, panels are packaged in completely enclosed wooden crates to provide optimum protection. Additional charges will apply. Contact UCC for further information on this non-standard packaging.

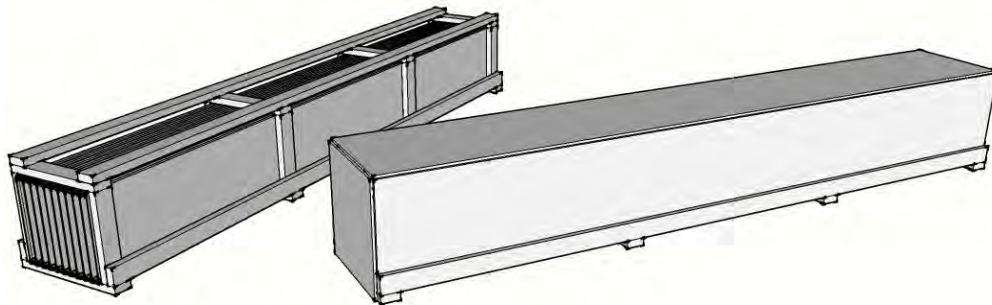

Figure 1: Packaging for panels (open crate and completely enclosed crate options)

- f. Unloading
- It is the responsibility of the installer to unload materials from the delivery truck. The installer shall be responsible for providing suitable equipment and means for unloading materials safely and without damaging product.
 - When handling crates and bundles always support unit from underneath. Position forks or slings in a manner that maintains proper balance.
 - Lift trucks with forks minimum 5 feet apart can be used for lifting bundles up to 25 feet long (*Figure 2*). Reasonable care should be taken while unloading to prevent damage from shocks or sudden movements.
 - Bundles over 25 feet in length should be lifted with nylon slings and a spreader bar. Never use chain, cable, or rope to lift bundles. As a general rule, no more than one third or maximum 15 feet of panel should be left unsupported.

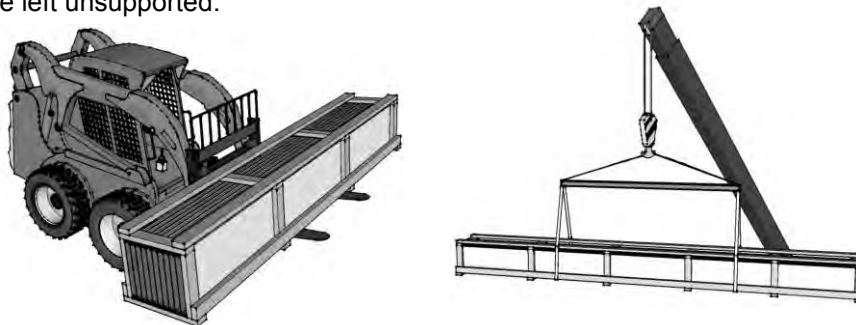

Figure 2: Lift truck with panel bundle. Crane with spreader bar and panel bundle.

g. Handling

- Individual panels should be carried on edge by hand and supported evenly with a maximum spacing of 10 to 12 feet (*Figure 3*).
- Handlers should maintain uniform movements while transporting panels to prevent bending or twisting that will cause permanent damage.

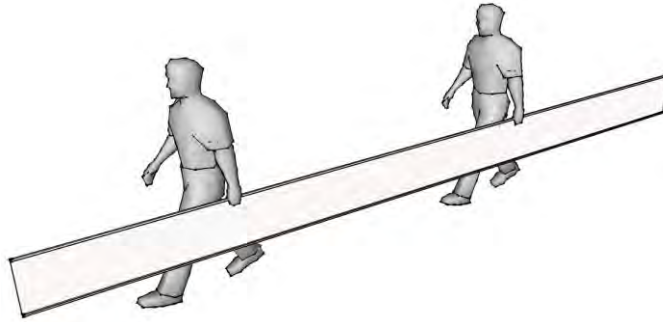

Figure 3: Carrying panels. Maintain maximum distance of 10-12 feet between holders

h. Storage

- Store all materials in a protected area away from standing water. Panels and trim should be covered to protect from moisture, debris, and long term exposure to sunlight. Keep bundles elevated above the ground to allow air to circulate freely. Elevate one end of bundles to prevent moisture from resting on surfaces.
- Exposure to dirt and moisture during storage can cause damage or staining of finish and material surfaces. Prolonged storage of panels and trim in bundles is not recommended. If conditions do not allow for immediate erection, extra care should be taken to protect materials from moisture. If panels and trim should contain moisture they should be dried and re-stacked.
- Panels and trim may have strippable polyfilm applied to surfaces for protection during fabrication, packaging, and transit. This film must be removed immediately prior to installation. Care should be taken to protect film from long term exposure to moisture and direct sunlight. Extended exposure to sunlight will cause polyfilm to be permanently adhered to panel surface.

2. WORKING WITH METAL

a. Cutting and Drilling

- DO NOT cut panels with saws or grinders. Only use appropriate sheet metal cutting tools designed to “shear cut” components with clean, burr free edges. Abrasive cutting mechanisms will damage Galvalume substrate and paint finishes and promote rusting of the steel components.
- Metal debris from cutting and drilling processes should be removed during installation. If not removed metal filings will red rust on the surfaces where they were deposited. Rusting of the metal filings may cause stain or discoloration on the surface of the panels and trim. Hot shavings should be prevented from coming into contact with painted surfaces. They may become embedded into the painted surface.

b. Expansion and Contraction

- Metal panels and trim are exposed to daily cycles of temperature changes from ambient temperatures and exposure to sunlight (*Table 1*). Temperature fluctuations cause metal components to expand and contract. Allowances should be made for the expansion and contraction of panels and trim. Restriction of expansion and contraction can produce “oil-canning” in panel/trim surfaces and cause failures at fastener locations.

Thermal Expansion/Contraction for Steel Roof Panels at 180° F Differential

Distance from fixed point	Nom. Expansion
10 feet	1/8" (0.145")
20 feet	5/16" (0.289")
30 feet	7/16" (0.434")
40 feet	9/16" (0.579")
50 feet	3/4" (0.724")
60 feet	7/8" (0.868")
70 feet	1" (1.013")
80 feet	1-3/16" (1.158")
90 feet	1-5/16" (1.302")
100 feet	1-7/16" (1.447")

Coefficient of expansion = 0.0000067 in/in/F

Table 1: Thermal Expansion/Contraction of Steel Panels

- Metal flashing and trim should be installed with sealed end laps that allow for expansion and contraction.
 - Panels should be installed with a “fixed” end and a “free” end. This manner allows for expansion and contraction to be controlled uniformly at one end of the roof. This manual follows the “architectural” or “steep slope” installation method which applies a point of fixity at the high end of the panels (i.e. ridge, hip, high wall, and peak). Expansion and contraction is accommodated at the low end of panels (i.e. eaves and valleys).
- c. Oil-Canning
- The perceived waviness in flat metal commonly known as “oil-canning” is an inherent part of light gauge cold formed metal panels and trim. UCC will not accept “oil-canning” as a cause for rejection.
 - Oil-canning can be minimized by means of heavier gauges, narrower panel widths and panel striations.
 - Substructure must be even plane to within ¼” in 20 feet from eave to ridge to avoid panel distortion.
- d. Dissimilar Metals
- DO NOT allow the steel roofing system to come into direct contact with dissimilar metals such as copper or brass. Corrosion caused by contact with dissimilar metals is not covered by UCC warranties.
 - DO NOT install steel roofing system in a location in which it will come directly in contact with moisture run-off from copper materials. Moisture run-off from copper materials will prematurely corrode steel components.
- e. Chemically Treated lumber
- Chemically treated lumber can be highly corrosive to metal roofing components. Care should be taken to separate metal components from direct contact with chemically treated wood. Corrosion caused by treated lumber is not covered by UCC warranties.
 - Use only stainless steel or ceramic coated fasteners for attachment to chemically treated wood.
- f. Graphite
- Avoid the use of graphite pencils when marking unpainted Galvalume steel components to avoid premature corrosion of material.

3. DESIGN INFORMATION

a. Planning

- It should be noted that this guide does not cover all conditions or situations for the design and applicability of UCC products for every project or installation.
- UCC recommends that a design professional be consulted to ensure proper design and application. Additional design assistance can be provided by contacting UCC.

b. Slope: Advantage-Lok II panel system is recommended for roof slopes of 3 inches in 12 and greater.

- Roof design should be free of any areas that pond water or impede water flow.
- Consult UCC for applications requiring slope less than 3 inches in 12.

c. Substrate: The Advantage-Lok II panel system requires a continuous solid substrate.

- The following is a list of acceptable substrates
 - Minimum 7/16" APA rated OSB or minimum 15/32" APA rated plywood
 - Nominal 1" or greater tongue and groove wood planks
 - Minimum 22 gauge steel decking
 - Rigid insulation (minimum 18 psi) over minimum 22 gauge steel decking or acceptable wood substrate (see above)
 - Minimum 7/16" APA rated OSB or minimum 15/32" APA rated plywood over rigid insulation over minimum 22 gauge steel decking
- Substrate Preparation
 - Substrate must be structurally sound and must meet the minimum requirements for the system performance (i.e. structural loading and wind uplift resistance).
 - Deck must not be out of plane more than 1/4" in 20 feet from eave to ridge.
 - Surface of substrate must be smooth, dry, and free of debris which might damage or distort panels.

d. Underlayment

- All installations of Advantage-Lok II panel over a solid substrate require the use of continuous layer of underlayment applied directly under the roof panels.
 - For slopes 3:12 and greater UCC recommends application of Repel™ synthetic underlayment or equal. Asphalt saturated felt paper (meeting ASTM D 226 Type II #30) may be used in lieu of synthetic underlayment but does not offer the strength and protection as synthetic underlayment.
 - Self-adhered membrane underlayment may be required for certain vulnerable detail conditions, slopes less than 3:12, certain deck assemblies, or when a UCC Weathertightness Warranty applies. Self-adhered underlayment should have the following minimum properties:
 - a. Smooth surfaced (non-granulated)
 - b. High temperature resistance (minimum 240° F)
 - c. Minimum thickness of 40 mil
 - d. Approved by the underlayment manufacturer for application under metal roofing

e. Insulation, Vapor retarders, & Air Barriers

- The necessity and location of insulation, a vapor retarder, and/or an air barrier is the responsibility of the building owner or designer. UCC does not accept responsibility for damage as a result of improper application of these items.
- The Advantage-Lok II panel can be installed directly over rigid insulation boards. Rigid insulation should have a minimum compressive strength of 18 psi. Metal bearing plates may be required to prevent fastening flange of panel from sinking into surface of insulation. Care should be taken to not overdrive panel fasteners. Panel fasteners must be long enough to attach panel to substrate located under rigid insulation.
- Rigid insulation shall be fastened to substrate with appropriate fasteners and insulation plates.
 - When panel installation is delayed after rigid insulation is installed, a minimum of 12 fasteners is recommended per 4 foot by 8 foot board.
 - When roof panels are installed immediately after rigid insulation is installed, a minimum of 5 fasteners per 4 foot by 8 foot board is acceptable.

f. Ventilation

- The necessity of venting the roof structure is the responsibility of the building owner or designer. UCC does not accept the responsibility for issues as a result of improperly vented roof systems.
- For single-family residential applications, FHA guidelines recommend the 1/300 rule: 1 square foot of net free vent area for every 300 square feet of attic floor space. Net free vent area includes exhaust and intake venting. It is recommended to use a ratio of 60% intake venting and 40% for exhaust venting. Some building codes may require the 1/150 rule. Always check with local building code for exact requirements.
- No attic vents should be installed between the intake and exhaust vents. This approach will “short circuit” the vent path between intake and exhaust vents leaving attic portions unvented.
- Ridge ventilation is the ideal method for venting a metal roof system.

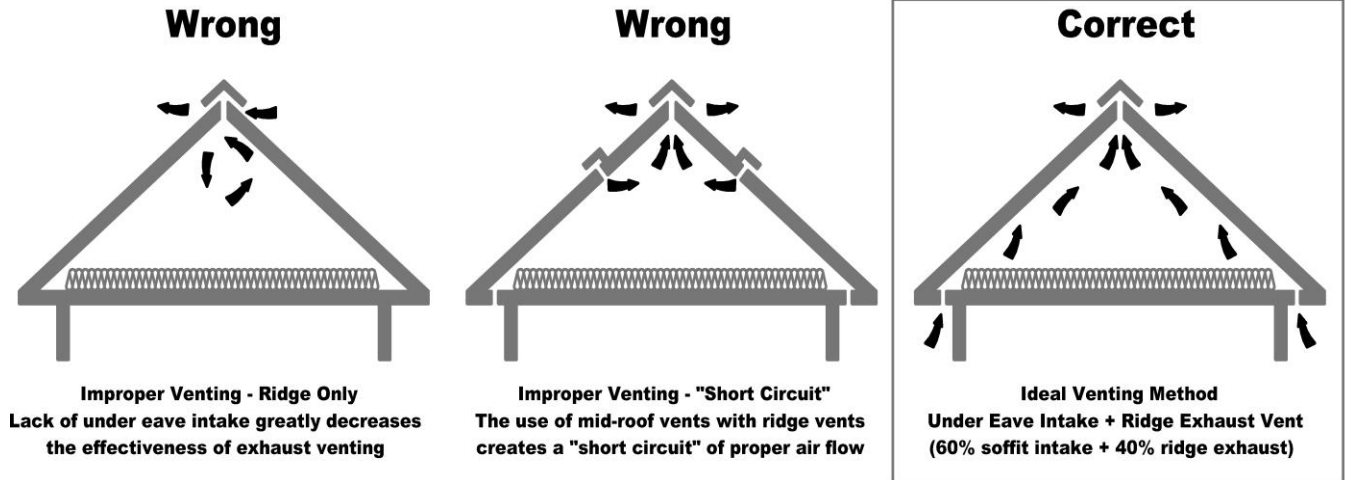
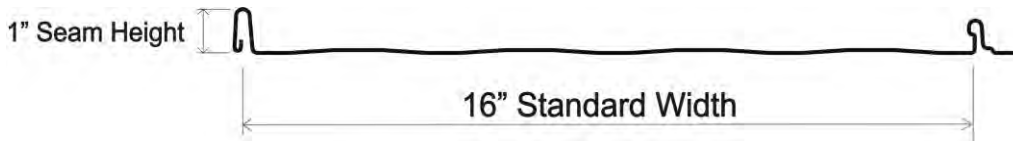

Figure 4: Proper venting method

4. PRODUCT INFORMATION

a. Advantage-Lok II Panel Description and Options



- Rib profile: 1 inch tall integral "snap" lock design with fastening flange
- Width: Standard panel width is 16 inches. Also available 11-5/8" width. Custom widths available.
- Profile: Standard panel profile is "striated". Other available options are smooth profile, 2 pencil ribs, and 2 bead (mesa) ribs. The striated profile option provides the best means for reducing the visibility of any potential oil-canning.

Optional Surface Patterns

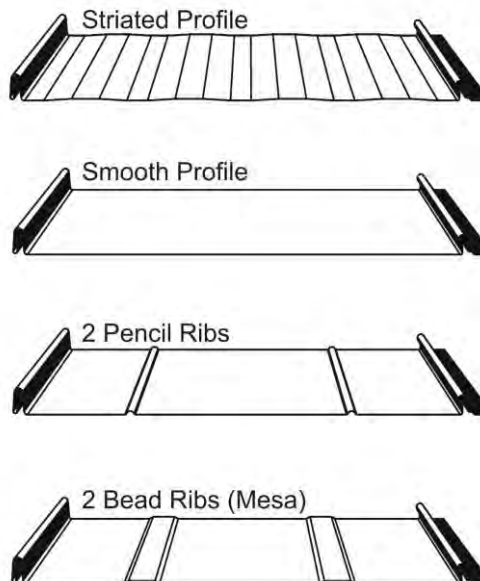

- Panel lengths: Standard lengths available from 3 to 48 feet. Longer lengths are available. Contact UCC for additional information regarding panel lengths greater than 48 feet.
 - Materials: Available in 26 and 24 gauge AZ-50 Galvalume coated steel and 0.032" aluminum.
 - Finishes: Available in unpainted Galvalume (with clear acrylic coating) or factory applied colored finishes. Kynar 500 Fluoropolymer finish is available in 24 gauge steel and 0.032" aluminum options. Siliconized Modified Polyester finish is available with 26 gauge option. Refer to color selection charts for finish choices.
- b. Panel Fasteners: Fasteners are applied through the fastening flange located on the male leg of panel. For most wood substrates the recommended fastener is a #10-12 x 1 inch long pancake head wood screw. Fasteners for wood should be of sufficient length to penetrate the substrate by ¼ inch or be imbedded into sheathing by ¾ inch. For minimum 22 gauge steel deck the recommended fastener is a minimum #12 pancake head self-drilling screw. Fasteners for steel decking should be sufficient length to penetrate substrate by ½ inch or 3 full threads. Refer to Tables 2 and 3 for recommended fastener spacing.

ASCE 7-05

MANUFACTURER'S RECOMMENDED PANEL ATTACHMENT GUIDE Advantage-Lok II 16" Panel x 26 gauge

In accordance with ASCE 7-05 Standard for Minimum Design Loads for Buildings and Other Structures
Substrate = Minimum 7/16" OSB or 15/32" Plywood

The following tables provide the minimum fastening rate for Advantage-Lok II panel system based on ASCE 7-05 "Standard for Minimum Design Loads for Buildings and Other Structures". Verify appropriate ASCE 7 version for use with applicable building code. Project specific engineering analysis may be required to verify that panel installation meets minimum design loads. Increased fastening may be required. Guide subject to change without notice.

Wind Speed (mph)	Mean Roof Hgt of 15'- 0" or Less			Mean Roof Hgt of 20'- 0" or Less			Mean Roof Hgt of 25'- 0" or Less		
	Zone 1	Zone 2	Zone 3	Zone 1	Zone 2	Zone 3	Zone 1	Zone 2	Zone 3
90	13.875"	13.875"	9.25"	13.875"	13.875"	9.25"	13.875"	9.25"	9.25"
100	13.875"	9.25"	9.25"	13.875"	9.25"	9.25"	13.875"	9.25"	9.25"
110	13.875"	9.25"	9.25"	13.875"	9.25"	4.6"	13.875"	9.25"	4.6"
120	13.875"	9.25"	4.6"	9.25"	9.25"	4.6" LS	9.25"	9.25"	4.6" LS
130	9.25"	9.25"	4.6" LS	9.25"	9.25"	4.6" LS	9.25"	4.6"	4.6" LS
140	9.25"	4.6"	4.6" LS	9.25"	4.6"	4.6" LS	9.25"	4.6"	4.6" LS

Wind Speed (mph)	Mean Roof Hgt of 30'- 0" or Less			Mean Roof Hgt of 35'- 0" or Less			Mean Roof Hgt of 40'- 0" or Less		
	Zone 1	Zone 2	Zone 3	Zone 1	Zone 2	Zone 3	Zone 1	Zone 2	Zone 3
90	13.875"	9.25"	9.25"	13.875"	9.25"	9.25"	13.875"	9.25"	9.25"
100	13.875"	9.25"	9.25"	13.875"	9.25"	9.25"	13.875"	9.25"	9.25"
110	13.875"	9.25"	4.6"	13.875"	9.25"	4.6"	13.875"	9.25"	4.6"
120	9.25"	9.25"	4.6" LS	9.25"	9.25"	4.6" LS	9.25"	9.25"	4.6" LS
130	9.25"	4.6"	4.6" LS	9.25"	4.6"	4.6" LS	9.25"	4.6"	4.6" LS
140	9.25"	4.6" LS	4.6"LS/RT	9.25"	4.6" LS	4.6"LS/RT	9.25"	4.6" LS	4.6"LS/RT

Fastener spacing based on the following design parameters:

1. Developed from design loads based on ASCE 7-05 with Exposure Category C and Risk Category II.
2. Substrate = Minimum 7/16" OSB sheathing or 15/32" APA rated plywood grade C-D.
3. Minimum slope = 2 inches in 12 inches
4. For gable or hip roof designs
5. Minimum gauge of panel = 26 gauge
6. Maximum panel width = 16 inches
7. Fastener = #10 x 1" pancake wood screw.
8. Enclosed Building. Open building design and overhang conditions not applicable with this guide.
9. Fasteners are located along fastening flange at expansion slot locations.

LS = Lap Sealant is required: Sikaflex 201, APS 500 tube sealant, or sealant with equal tensile properties.

Sealant is applied in continuous 3/16" bead along side of male rib (adjacent to fastening flange).

LS/RT = Lap Sealant and Retainer Strip required. Contact UCC for detailed application instructions.

Table 2: Recommended Fastener Spacing [ASCE 7-05]

ASCE 7-10

MANUFACTURER'S RECOMMENDED PANEL ATTACHMENT GUIDE Advantage-Lok II 16" Panel x 26 gauge

In accordance with ASCE 7-10 Standard for Minimum Design Loads for Buildings and Other Structures
Substrate = Minimum 7/16" OSB or 15/32" Plywood

The following tables provide the minimum fastening rate for Advantage-Lok II panel system based on ASCE 7-10 "Standard for Minimum Design Loads for Buildings and Other Structures". Verify appropriate ASCE 7 version for use with applicable building code. Project specific engineering analysis may be required to verify that panel installation meets minimum design loads. Increased fastening may be required. Guide subject to change without notice.

Wind Speed (mph)	Mean Roof Hgt of 15'- 0" or Less			Mean Roof Hgt of 20'- 0" or Less			Mean Roof Hgt of 25'- 0" or Less		
	Zone 1	Zone 2	Zone 3	Zone 1	Zone 2	Zone 3	Zone 1	Zone 2	Zone 3
115	13.88"	13.88"	9.25"	13.88"	13.88"	9.25"	13.88"	9.25"	9.25"
120	13.88"	13.88"	9.25"	13.88"	9.25"	9.25"	13.88"	9.25"	9.25"
130	13.88"	9.25"	9.25"	13.88"	9.25"	9.25"	13.88"	9.25"	9.25"
140	13.88"	9.25"	9.25"	13.88"	9.25"	4.6"	13.88"	9.25"	4.6"
150	13.88"	9.25"	4.6"	13.88"	9.25"	4.6"	13.88"	9.25"	4.6"
160	9.25"	9.25"	4.6" LS	9.25"	9.25"	4.6" LS	9.25"	9.25"	4.6" LS
170	9.25"	9.25"	4.6" LS	9.25"	4.6"	4.6" LS	9.25"	4.6"	4.6" LS
180	9.25"	4.6"	4.6" LS	9.25"	4.6"	4.6" LS	9.25"	4.6"	4.6" LS

Wind Speed (mph)	Mean Roof Hgt of 30'- 0" or Less			Mean Roof Hgt of 35'- 0" or Less			Mean Roof Hgt of 40'- 0" or Less		
	Zone 1	Zone 2	Zone 3	Zone 1	Zone 2	Zone 3	Zone 1	Zone 2	Zone 3
115	13.88"	9.25"	9.25"	13.88"	9.25"	9.25"	13.88"	9.25"	9.25"
120	13.88"	9.25"	9.25"	13.88"	9.25"	9.25"	13.88"	9.25"	9.25"
130	13.88"	9.25"	9.25"	13.88"	9.25"	9.25"	13.88"	9.25"	4.6"
140	13.88"	9.25"	4.6"	13.88"	9.25"	4.6"	13.88"	9.25"	4.6"
150	9.25"	9.25"	4.6" LS	9.25"	9.25"	4.6" LS	9.25"	9.25"	4.6" LS
160	9.25"	9.25"	4.6" LS	9.25"	4.6"	4.6" LS	9.25"	4.6"	4.6" LS
170	9.25"	4.6"	4.6" LS	9.25"	4.6"	4.6" LS	9.25"	4.6"	4.6" LS
180	9.25"	4.6"	4.6"LS/RT	9.25"	4.6" LS	4.6"LS/RT	9.25"	4.6" LS	4.6"LS/RT

Fastener spacing based on the following design parameters:

1. Developed from design loads based on ASCE 7-10 with Exposure Category C and Risk Category II.
2. Substrate = Minimum 7/16" OSB sheathing or 15/32" APA rated plywood grade C-D.
3. Minimum slope = 2 inches in 12 inches
4. For gable or hip roof designs
5. Minimum gauge of panel = 26 gauge
6. Maximum panel width = 16 inches
7. Fastener = #10 x 1" pancake wood screw.
8. Enclosed Building. Open building design and overhang conditions not applicable with this guide.
9. Installation should be verified with conformance to applicable building code. Refer to Florida Product Approval **FL20484.2** for additional installation requirements.
10. Fasteners are located along fastening flange at expansion slot locations.

LS = Lap Sealant is required: Sikaflex 201, APS 500 tube sealant, or sealant with equal tensile properties. Sealant is applied in continuous 3/16" bead along side of male rib (adjacent to fastening flange).

LS/RT = Lap Sealant and Retainer Strip required. Contact UCC for detailed application instructions.

Table 3: Recommended Fastener Spacing [ASCE 7-10]

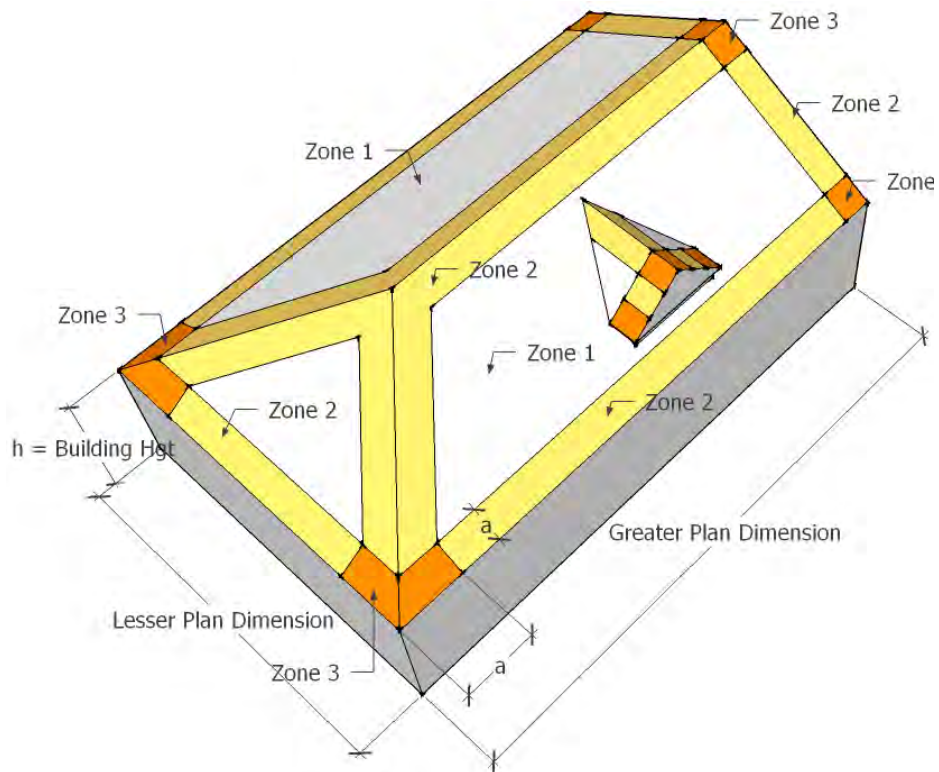

Figure 5: Roof Zones

Determining Perimeter (Zone 2) and Corner (Zone 3) Areas:

Dimension 'a' = The lesser value of 10% of the "Lesser Plan Dimension" or 40% of the Mean Roof Height ($0.1 \times \text{"Lesser Plan Dimension"}$ or $0.4 \times \text{Mean Roof Height}$)

Note: 'a' is never less than 4% of the "Lesser Plan Dimension" ($0.04 \times \text{"Lesser Plan Dimension"}$) or minimum 4'-0" wide.

-
- c. Sealants: Sealant is a necessary component to prevent water from infiltrating thru the metal roofing system. It is applied to joints, laps, intersections, and perimeter edges of panels and flashings. It is also applied to laps and joints of gutters and downspouts to control water containment to ground level. Refer to Advantage-Lok II Master Detail Sets for determining proper application of sealant.
- Tape Sealant: Tape sealant is a non-drying sealant with excellent physical and weathering characteristics. It has a high dimensional stability which makes it ideal for use where the mating surfaces are in compression such as between zee closure flashing and roof panels. Tape sealant should NOT be used as a surface sealant or where the sealant is not compressed between the two mating surfaces. Tape sealant should NOT be installed where exposed to direct sunlight.
 - Material: Butyl-polyiso-butylene base extruded compound
 - Dimensions: 1/8" thick x 7/8" double bead x 45 feet roll with release paper
 - Tube Sealants: Tube sealants can be used in virtually all locations where sealant is required. It can be used between mating surfaces or applied as an exposed surface sealant. For best results, tool sealant into corners or mating surfaces to ensure continuous adhesion to material surfaces and eliminate voids.
 - Types of tube sealants:
 - a. Polyurethane Sealants: Polyurethane is a medium modulus organic sealant. The sealant cures to a flexible rubber when exposed to atmospheric moisture. Polyurethane should NOT be installed where exposed to direct sunlight.
 - b. Silicone, Modified Silicone, and Co-polymer Sealants: These sealant types are low to medium modulus and exhibit high resistance to UV.
 - Packaging: Tube sealants are available in +/- 10 oz. cartridges and have an approximate coverage rate of 25 lineal feet for ¼ inch bead diameter.
 - d. Metal Flashings and Trim: Flashings and trim are brake-formed components applied at roof perimeters, intersections, transitions, and junctions to prevent water infiltration. They are typically provided in matching gauges and finishes to the roof panels but can be contrasting materials and colors. Standard flashing/trim lengths are 10 feet. Custom lengths up to 20 feet can be provided. Contact UCC for additional information on non-standard lengths and profiles.

5. INSTALLATION INSTRUCTIONS

a. Tools and Accessories

- Minimum recommended tools for installation
 - Sheet metal snips (left and right hand): for general cutting of trims and panels
 - Long handled pattern (bulldog) snips: for long cuts in trims and panels
 - Locking style C-clamps: for holding panels and trims in position during cutting and drilling
 - 3" hand seamers (duckbill folder): for bending sheet metal tabs and hems
 - Panel hemming tool (16"): for forming hem on panel ends at eaves and valleys
 - Pop rivet tool: for installing #42 (1/8" diameter) rivets in trims, flashing, and guttering
 - Hammer
 - Chalk line
 - Tape measure
 - Electric screw gun
 - Drill bits (1/8" diameter)
 - Electric sheet metal shears: for long cuts in trims and panels
 - Marking pens: for marking cuts in sheet metal components
 - Utility knife
 - Caulk gun

b. Underlayment Installation:

- Underlayment should be installed continuous over entire substrate
- Roof deck must be clean and free from any moisture, ice, dust, loose nails, protrusions, voids, and other debris
- Use minimum 4" horizontal laps and minimum 12" vertical (end) laps.
- Start at lowest portion of roof. Apply with printed side up. Extend underlayment over roof edges (eaves and rakes) minimum 1-1/2". Install full course centered along valleys.
- Extend underlayment minimum 6" up vertical termination details (i.e. sidewall and highwalls).

- Synthetic underlayment is mechanically fastened to substrate. Use only electroplated, galvanized, or coated fasteners. Use of “common steel” (uncoated) roofing nails may result in rusting that can spread to the underside of metal roof panels and flashings. DO NOT use staples for application of underlayment. Apply nails at 6 inches on center along head and end laps and 24 inches on center along the center of each course.
 - Self-adhered membrane underlayment to be applied with release paper towards roof surface. Remove release paper diagonally from bottom of roll while applying heavy hand pressure to top surface. Refer to manufacturer’s requirements for minimum application temperatures and instructions for cold weather installation.
 - Underlayment left exposed to elements for a period beyond the manufacturer’s recommended exposure duration should be completely replaced or covered with new.
- c. Advantage-Lok II Panel Installation
- For best performance, panels should extend full length from low point (eave and valley conditions) to high point (hip, ridge, peak, and highwall conditions). Field splicing of panels is possible but not recommended. Splicing may be considered when panel runs exceed maximum shippable lengths. Contact UCC for additional information on field splicing and maximum shipping lengths.
 - Panels should be hemmed around drip edges and cleats at lowest points to allow for expansion and contraction. Panel hemming is performed in field by installer. Refer to *Table 4* “Thermal Gap Installation Chart” and *Figure 6* for hem lengths and gap settings.

Thermal Gap Installation Chart for Steel Roof Panels at 180° F Differential

Distance from fixed point	Material Temperature During Installation		
	Hot (>100° F)	Warm (100° to 50° F)	Cold (<50° F)
10 feet	1/8" (0.145")	1/16" (0.072")	0
20 feet	5/16" (0.289")	1/8" (0.145")	0
30 feet	7/16" (0.434")	3/16" (0.217")	1/8" (0.125")
40 feet	9/16" (0.579")	5/16" (0.289")	1/8" (0.125")
50 feet	3/4" (0.724")	3/8" (0.362")	3/16" (0.188")
60 feet	7/8" (0.868")	7/16" (0.434")	3/16" (0.188")
70 feet	1" (1.013")	1/2" (0.507")	1/4" (0.25")
80 feet	1-3/16" (1.158")	9/16" (0.579")	1/4" (0.25")
90 feet	1-5/16" (1.302")	5/8" (0.651")	3/8" (0.375")
100 feet	1-7/16" (1.447")	3/4" (0.724")	3/8" (0.375")

*Coefficient of expansion = 0.0000067 in/in/F

Table 4: Thermal Gap Installation Chart

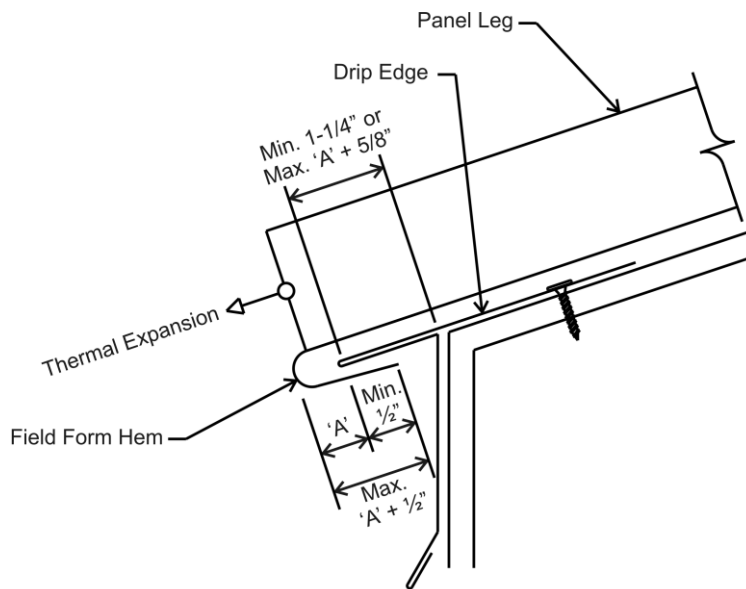

'A' = Gap from Thermal Expansion Chart during time of installation

Figure 6: Setting Panel Thermal Gap During Installation

- Panel hemming:
 - Notch vertical legs back from eave end of panel equal to hem length (nominally 1 inch or maximum dimension provided by *Figure 6*).
 - Use panel hemming tool to fold panel end 180 degrees.

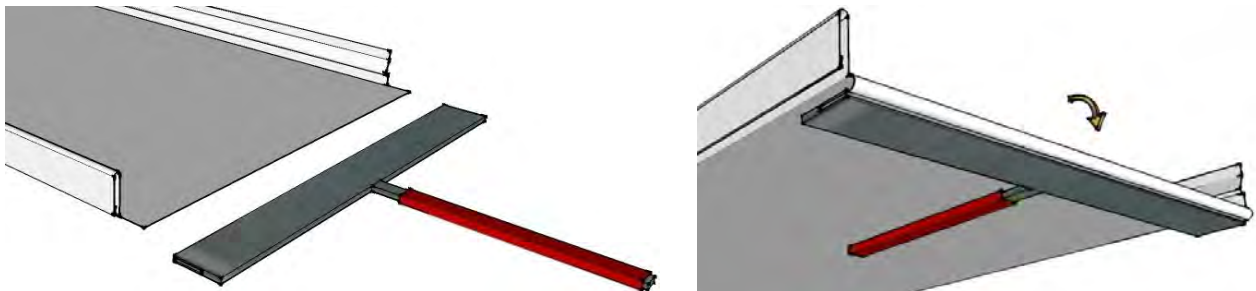

Figure 7: Panel Hemming

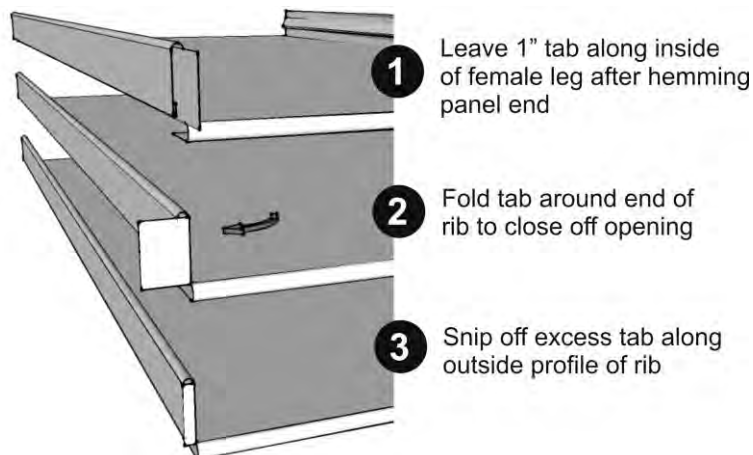

Figure 8: Closing Female Rib End (optional)

- Installing Panels
 - The following flashing assemblies must be installed prior to installing panels:
 - a. Eave drip edge
 - b. Valley flashing
 - c. Gable Trims (sub-panel flashings only)
 - Panel installation must begin at an extreme lower left or right position for each roof plane to be covered. Installation can proceed in only one direction across plane of roof.
 - Install first panel. Hook hemmed end onto eave drip edge or offset cleat. Fasten upper most end of panel to substrate with single fastener into substrate to secure panel in place.
 - Install panel fasteners along fastener flange of male leg of panel at required spacing interval. Refer to *Table 2 or 3* for spacing guidelines. It is recommended to install two fasteners together near the eave end of the panels to provide additional resistance against wind uplift which can be significant at roof edges.
 - Install second panel by loosely lapping female leg over male leg. Let lower panel end (eave end) extend off roof edge so panel hem does not interfere with drip edge. With hand pressure, snap down lower end of panel only so that panel hem is below extended lip of drip edge. Carefully slide panel up slope to fully engage panel hem around lip of drip edge. Set expansion gap as indicated in *Figure 6*. Snap down female rib onto male rib with hand pressure starting at eave and working upslope. CAUTION: Use of hammer or mallet to snap panels together may damage panel rib or cause panels to dent at fastener locations.
 - Continue to install remaining panels in same manner as above.
 - It is important to check for modularity (dimension across panel width) as panels are installed. Measure across multiple ribs at both ends of panels to verify that panels are installed square. Failure to maintain modularity will result in poor alignment at eave (“saw-tooth affect”) and noticeable dimension variations along parallel gable edges and walls. Slight corrections can be made by applying counter adjustments at panel ends to the next several panels. Do not apply more than 1/8 inch gap at each side lap when making adjustments.
- d. Installing Trim & Flashing Details
 - Refer to select details included at the end of this product manual (page 28) and separate **Advantage-Lok II Standing Seam Master Detail** sets for additional installation details and product information.



Figure 9: Advantage-LokII Standing Seam Master Detail Set

- Eave Detail (page 29):
 - Install first section of extended eave drip edge tight to roof edge over first layer of underlayment. Fasten with appropriate substrate fastener at 8 inches on center in a staggered pattern.
 - Install additional sections of extended eave drip edge with minimum 4 inch end laps and tube sealant at laps.
- Gable Detail - drip edge style (page 31):
 - Install first section of extended gable drip edge tight to roof edge over underlayment. Fasten with appropriate substrate fastener at 8 inches on center in a staggered pattern.
 - Install additional sections of extended eave drip edge with minimum 4 inch end laps and tube sealant at laps.
- Gable - box style with zee closure (page 31):
 - Install panels continuous across roof area to outside face of gable edge.
 - Apply continuous row of 7/8 inch double bead tape sealant to base of zee closure. Mark face of roof panel from gable edge to corresponding width of box gable trim. Install zee closure along entire length of roof panel following markings. A short section of box gable trim can be used as a guide to better position of zee closures. Fasten with appropriate substrate fastener at minimum 4 fasteners per zee or 12 inches on center.
 - Install continuous cleat along face of fascia board with appropriate fastener at 8 inches on center.
 - Install box gable trim by hooking onto cleat and lapping over top flange of zee closure. Provide minimum 4 inch end laps and sealant at laps.
 - Pop rivet box gable trim to top flange of zee closure at 18 inches on center.
- Valley Detail - with separate offset cleat (page 32):
 - Install lowest section of valley flashing first by notching and hemming minimum 1 inch around drip edge.
 - Fasten both sides of valley with appropriate substrate fastener just below hemmed edge at 12 inches on center.
 - Continue installing sections of valley flashing up slope. Provide minimum 12 inch end laps with 2 rows of tube sealant at laps.
 - Apply continuous row of 7/8 inch double bead tape sealant to one side of continuous offset cleat. Install offset cleat minimum 4 inches from center line of valley on both sides. Fasten offset cleat with appropriate substrate fastener at maximum 8 inches on center.
 - Lap field courses of underlayment minimum 4 inches on both sides of valley flashing.
 - Install roof panels with hemmed end by hooking onto offset cleat on both sides of valley flashing. Care should be taken to protect valley flashing from being scratched by hemmed edge while panels are slid into place.
 - Do not install panel fasteners through valley flashing. First panel fastener should be located just above valley edge.
- Hip Detail (page 32):
 - Install panels continuous across roof areas along both sides of hip line.
 - Field cut zee closure flashing to fit tight between panel ribs. Apply continuous row of 7/8 inch double bead tape sealant to base of zee closure. Install zee closures onto panels at both sides. Use hip flashing to locate correct position of zee closures. Fasten with appropriate substrate fastener at minimum 4 fasteners per zee or 3 inches on center.
 - Apply a row of tube sealant along back face of zee closure adjacent to panel legs.
 - Install hip flashing onto zee closures by hooking hemmed edge onto top flange of zee. Rivet hip flashing to top flange of zees at 18 inches on center both sides.
 - Install additional sections of hip flashings with minimum 4 inch end laps and tube sealant at laps.
- Sidewall Detail - with zee closure (page 35):
 - Install panels continuous across roof area to face of wall.
 - Apply continuous row of 7/8 inch double bead tape sealant to base of zee closure. Mark face of roof panel from face of wall to corresponding width of sidewall trim. Install zee closure along entire length of roof panel following markings. A short section of sidewall trim can be used as a guide to better position of zee closures. Fasten with appropriate substrate fastener at minimum 4 fasteners per zee or 12 inches on center.







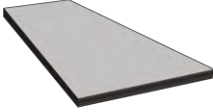

- Install sidewall flashing by hooking open hem onto top flange of zee closure and positioning vertical face against wall. Use appropriate fastener at 12 inches on center to secure flashing to wall. Provide minimum 4 inch end laps and sealant at laps.
- Pop rivet sidewall flashing to top flange of zee closure at 18 inches on center.
- If applicable, install reglet counter flashing or surface mounted counter flashing along wall. Seal top edge with tube sealant.
- Highwall (headwall) Detail (page 34):
 - Install panels continuous over adjacent roof section.
 - Field cut zee closure flashing to fit tight between panel ribs. Apply continuous row of 7/8 inch double bead tape sealant to base of zee closure. Install zee closures onto panels at both sides. Use highwall flashing to locate correct position of zee closures. Fasten with appropriate substrate fastener at minimum 4 fasteners per zee or 3 inches on center.
 - Apply row of tube sealant along back face of zee closure adjacent to panel legs.
 - Install highwall flashing onto zee closures by hooking hemmed edge onto top flange of zee. Use appropriate fastener at 12 inches on center to secure flashing to wall. Provide minimum 4 inch end laps and sealant at laps. Rivet flashing to top flange of zeets at 18 inches on center.
- Ridge Detail (page 32):
 - Install panels continuous across roof areas along both sides of ridge line.
 - Field cut zee closure flashing to fit tight between panel ribs. Apply continuous row of 7/8 inch double bead tape sealant to base of zee closure. Install zee closures onto panels at both sides. Use ridge flashing to locate correct position of zee closures. Fasten with appropriate substrate fastener at minimum 4 fasteners per zee or 3 inches on center.
 - Apply row of tube sealant along back face of zee closure adjacent to panel legs.
 - Install ridge flashing onto zee closures by hooking hemmed edge onto top flange of zee. Rivet ridge flashing to top flange of zeets at 18 inches on center both sides.
 - Install additional sections of ridge flashings with minimum 4 inch end laps and tube sealant at laps. Rivet lapped ridge sections together. Provide a ridge expansion detail every 40 feet of ridge length to allow for thermal expansion/contraction.
- Vented Ridge Detail - with perforated cleat (page 33):
 - Install panels continuous across roof areas along both sides of ridge line.
 - Field cut zee closure flashing to fit tight between panel ribs. Apply continuous row of 7/8 inch double bead tape sealant to base of zee closure. Install zee closures onto panels at both sides. Use ridge flashing with perforated vent cleat to locate correct position of zee closures. Fasten with appropriate substrate fastener at minimum 4 fasteners per zee or 3 inches on center.
 - Apply row of tube sealant along back face of zee closure adjacent to panel legs.
 - Install perforated vent cleat along top of flange of zee closure both sides of ridge. Allow 2 inches of vent cleat to extend below flange of zee closure. Rivet vent cleat to zeets at 12 inches on center.
 - Install ridge flashing onto vent cleats by hooking hemmed edge onto edge of cleats. Rivet ridge flashing to vent cleat at 18 inches on center both sides.
 - Install additional sections of ridge flashings with minimum 4 inch end laps and tube sealant at laps. Rivet lapped ridge sections together. Provide a ridge expansion detail every 40 feet of ridge length to allow for thermal expansion/contraction.
- Peak Detail (page 34):
 - Install panels continuous over adjacent roof section.
 - Field cut zee closure flashing to fit tight between panel ribs. Apply continuous row of 7/8 inch double bead tape sealant to base of zee closure. Install zee closures on to panels at both sides. Use highwall flashing to locate correct position of zee closures. Fasten with appropriate substrate fastener at minimum 4 fasteners per zee or 3 inches on center.
 - Apply row of tube sealant along back face of zee closure adjacent to panel legs.
 - Install continuous cleat along face of fascia board with appropriate fastener at 8 inches on center.
 - Install peak flashing by first hooking onto cleat and then hooking onto top flange of zee. Provide minimum 4 inch end laps and sealant at laps. Rivet flashing to top flange of zeets at 18 inches on center.
- Pipe Penetrations (page 37):
 - Cut round opening through panel leaving approximately ½ inch gap around pipe.

- Apply continuous bead of tube sealant around base of pipe at panel surface.
- Note: Use EPDM pipe flashing (siliconized pipe flashing for high temperature pipes) with round base and integral aluminum base ring.
- Cut opening in top of pipe flashing slightly smaller than pipe diameter.
- Apply continuous bead of tube sealant to bottom of pipe flashing base and install boot over pipe and position base against panel surface.
- Install HWH screws with washer around base of pipe flashing at 1 inch on center.
- Apply continuous bead of tube sealant around top and base of pipe flashing.
- Install stainless steel clamping ring around top of pipe flashing.
- Square Penetrations (page 38): Refer to step by step illustrations and instructions for installing square curb style penetrations at the end of this manual (beginning at page 38).

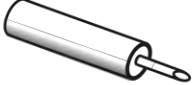





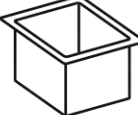

6. Roof Protection and Repair

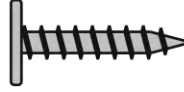
- a. Roof Protection During Installation: During roof installation be careful to prevent damage to panels and trims such as scratches, dents, and paint abrasion. This can be caused by construction materials, tools, safety equipment, and workers on roof. Most damage can be prevented by the following means:
 - Minimize traffic on installed portions of roof from workers.
 - Use soft soled footwear. Be sure to clean debris from bottom of footwear before climbing onto roof.
 - Remove metal scraps and other construction debris from roof daily.
 - Immediately remove metal shavings from the surface of panels and trim that occur from cutting and drilling processes.
- b. Roof Protection After Installation: After installation of roof it is advisable to perform periodic inspections and maintenance of roof to ensure proper performance. The following are recommended maintenance points:
 - Roof should be kept clean. Remove all trash, debris, and dirt from roof. Debris such as leaves and sticks may hinder the drainage of water in valleys and gutters. Debris and dirt hold moisture against the roof surface and prevent the roof from drying completely. Constant exposure to moisture can lead to paint failure and rusting of panels.
 - Trim back any overhanging tree branches
 - Penetrations: Close attention should be given to roof penetrations (pipes and curbs). For pipe penetrations, check that flexible rubber boots are properly secured to roof and pipe. If cracks or tears are observed in boot the boot should be removed and replaced.
 - Snow/Ice Removal: If it is required that snow be removed from roof surface, do not use mechanical means that would scratch or otherwise damage the finish of the roof system.
- c. Finishes and Touchup: Take care to protect material surfaces to protect finish from scratches and abrasions that may void finish warranty and result in failure of finish. Touch up paint may be obtained from UCC. Apply touchup paint to scratches as required. Note that touchup paint does not have the same durability and color retention qualities as the factory applied paint finish and thus should be applied sparingly. Apply only enough paint to completely cover the scratched area to avoid unsightly finish variations. Do not use aerosol paint applicators for touch up.
- d. Repairs to Roof: Should repairs be needed, it is recommended that only qualified installers that are experienced in installing metal roofing systems perform the work.

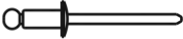
Accessories Guide

<p>Flat Sheets</p>  <ul style="list-style-type: none"> <input type="checkbox"/> 26 ga. Galvalume, 41-9/16" wide x 120" long Finishes: Bare or SMP Colors <input type="checkbox"/> 24 ga. Galvalume, 48" wide x 120" long Finishes: Bare or Kynar Colors <input type="checkbox"/> 0.032" Aluminum, 48" wide x 120" long Finishes: Kynar Colors <p>Available in matching gauge and color as roof panels. Use for fabrication of trims and flashings. Protective strippable film applied over finish side.</p>	<p>Repel™ Underlayment</p>  <ul style="list-style-type: none"> <input type="checkbox"/> Repel™ Synthetic Underlayment 48" wide x 250' long rolls 10 squares per roll
<p>Tube Sealant</p>  <ul style="list-style-type: none"> <input type="checkbox"/> Geocel 2300 Tripolymer (general use sealant) Color: Clear <input type="checkbox"/> Ultra 1000 Premium Sealant *Special Order Item Colors: Translucent, Gutter Gray, Dark Bronze, White, Sandstone, Red, Green <input type="checkbox"/> Polyurethane Color: Gray 	<p>Tape Sealant</p>  <ul style="list-style-type: none"> <input type="checkbox"/> Double Bead Butyl Tape Sealant 7/8" wide x 3/16" thick x 40 foot roll 35 rolls per box <p>For use under offset cleats and zee closures</p>
<p>Pipe Boot</p>  <ul style="list-style-type: none"> <input type="checkbox"/> #3 Boot - Fits 1/4" to 5" diameter (8" base) <input type="checkbox"/> #4 Boot - Fits 3" to 6" diameter (9-1/2" base) <input type="checkbox"/> #5 Boot - Fits 4" to 7" diameter (11" base) <input type="checkbox"/> #6 Boot - Fits 5" to 9" diameter (12-3/4" base) <p>Available in Black or Gray EPDM</p>	<p>High Temperature Pipe Boot</p>  <ul style="list-style-type: none"> <input type="checkbox"/> #3 Boot - Fits 1/4" to 5" diameter (8" base) <input type="checkbox"/> #4 Boot - Fits 3" to 6" diameter (9-1/2" base) <input type="checkbox"/> #5 Boot - Fits 4" to 7" diameter (11" base) <input type="checkbox"/> #6 Boot - Fits 5" to 9" diameter (12-3/4" base) <p>High Temperature Resistant, Orange Silicone</p>
<p>Retrofit Pipe Boot</p>  <ul style="list-style-type: none"> <input type="checkbox"/> #1 Boot - Fits 3/4" to 2-3/4" diameter <input type="checkbox"/> #2 Boot - Fits 2" to 7-1/4" diameter <input type="checkbox"/> #3 Boot - Fits 3-1/4" to 10" diameter <p>Retrofit Pipe Boot For use with "wrap-around" applications Available in Black EPDM</p>	<p>Touch-Up Paint</p>  <ul style="list-style-type: none"> <input type="checkbox"/> 2 oz. can for Kynar colors <input type="checkbox"/> 0.6 oz. bottle for SMP colors <p>To touch-up small scratches and abrasions Note: Color match with roof is not guaranteed</p>
<p>Gutter Hanger</p>  <ul style="list-style-type: none"> <input type="checkbox"/> 5" Hidden Gutter Hanger <input type="checkbox"/> 6" Hidden Gutter Hanger <input type="checkbox"/> 7" Hidden Gutter Hanger <input type="checkbox"/> 8" Hidden Gutter Hanger <p>Hidden Gutter Hanger, 18 ga. Galvanized</p>	<p>Outlet Tube</p>  <ul style="list-style-type: none"> <input type="checkbox"/> 3" x 4" <input type="checkbox"/> 4" x 5" <input type="checkbox"/> Custom Size: _____ <p>Downspout Outlet Tube For use with rectangular downspouts</p>

Accessories Guide

<p>Pancake Head Wood Screw</p>  <ul style="list-style-type: none"> <input type="checkbox"/> #10-12 x 1" long <input type="checkbox"/> #10-12 x 1-1/2" long <input type="checkbox"/> #10-12 x 2" long <input type="checkbox"/> #10-12 x 2-1/2" long <input type="checkbox"/> #10-12 x 3" long <p>Zinc plated, Quadrex bit For attachment of panels and flashings to wood</p>	<p>Stainless Pancake Head Wood Screw</p>  <ul style="list-style-type: none"> <input type="checkbox"/> #10-12 x 1" long <div style="border: 1px solid black; padding: 2px; width: fit-content; margin: 5px auto;"> <p><i>Recommended for use with aluminum panels</i></p> </div> <p>Stainless Steel, Quadrex bit For attachment of panels and flashings to wood</p>
<p>Pancake Head Self-Drilling Screw</p>  <ul style="list-style-type: none"> <input type="checkbox"/> #10-16 x 1" long <input type="checkbox"/> #12-14 x 1" long <p>Zinc Plated, Quadrex bit For attachment of panels & flashings to steel</p>	<p>Pop Rivet</p>  <ul style="list-style-type: none"> <input type="checkbox"/> #1/8 x 3/16" long, Stainless Steel Rivet Finish: Painted to match panels <p>For sheet metal joining. Predrill w/ 1/8" hole.</p>
<p>Lap Tek (Stitch) Screw</p>  <ul style="list-style-type: none"> <input type="checkbox"/> #1/4-14 x 7/8" long Finish: Plain or painted to match panels <p>5/16" HWH w/ washer, Zinc Plated For sheet metal joining</p>	<p>Long-Life Lap Tek (Stitch) Screw - UltiMate®</p>  <ul style="list-style-type: none"> <input type="checkbox"/> #1/4-14 x 7/8" long Finish: Plain or painted to match panels <p>5/16" HWH Zinc Alloy Head w/ washer For sheet metal joining</p>
<p>HWH Wood Screw</p>  <ul style="list-style-type: none"> <input type="checkbox"/> #10-14 x 1" long <input type="checkbox"/> #10-14 x 2" long <input type="checkbox"/> #10-14 x 3" long <input type="checkbox"/> #10-14 x 1-1/2" long <input type="checkbox"/> #10-14 x 2-1/2" long <p>1/4" HWH w/ washer, Zinc Plated Finish: Plain or painted to match panels To attach sheet metal components to wood</p>	<p>Long-Life HWH Wood Screw - UltiMate®</p>  <ul style="list-style-type: none"> <input type="checkbox"/> #10-14 x 1" long <input type="checkbox"/> #10-14 x 2" long <input type="checkbox"/> #10-14 x 1-1/2" long <input type="checkbox"/> #10-14 x 2-1/2" long <p>5/16" HWH Zinc Alloy Head w/ washer Finish: Plain or painted to match panels To attach sheet metal components to wood</p>
<p>HWH Self-Drilling Screw</p>  <ul style="list-style-type: none"> <input type="checkbox"/> #12-14 x 1" long <input type="checkbox"/> #12-14 x 1-1/2" long <input type="checkbox"/> #12-14 x 1-1/4" long <input type="checkbox"/> #12-14 x 2-1/2" long <p>5/16" HWH w/ washer, DP2, Zinc Coated Finish: Plain or painted to match panels To attach sheet metal components to steel</p>	<p>Long-Life HWH Self-Drilling Screw - UltiMate®</p>  <ul style="list-style-type: none"> <input type="checkbox"/> #12-14 x 1-1/4" long <p>5/16" HWH Zinc Alloy Head w/ washer, DP2 Finish: Plain or painted to match panels To attach sheet metal components to steel</p>

Flashings and Trims

SS10

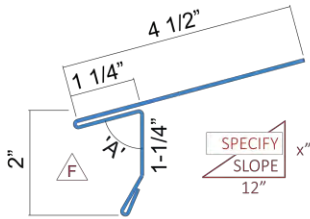

Standard Extended Eave, 2" Face
For all slopes from 1:12 to 7:12

SS11

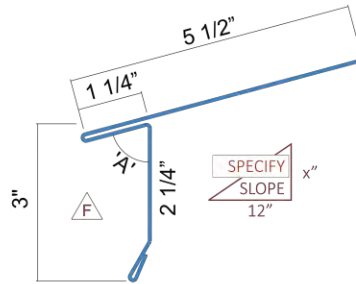

Standard Extended Eave, 3" Face
For slopes from 1:12 to 7:12

SS12

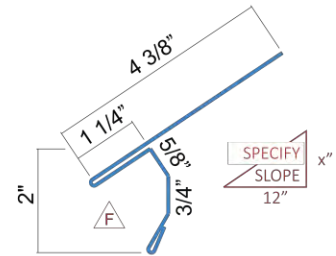

Steep Slope Extended Eave, 2" Face
For slopes up to 12:12

SS13

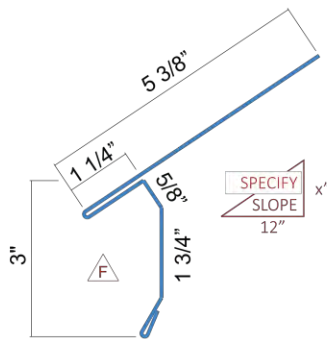

Steep Slope Extended Eave, 3" Face
For slopes up to 12:12

SS14

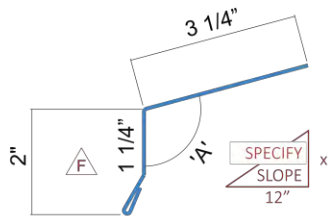

Eave Drip Edge, 2" Face
For all slopes

SS15

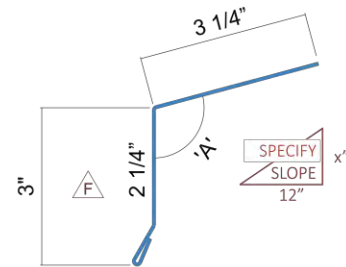

Eave Drip Edge, 3" Face
For all slopes

SS16

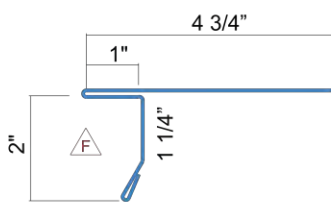

Extended Gable Trim, 2" Face

SS17

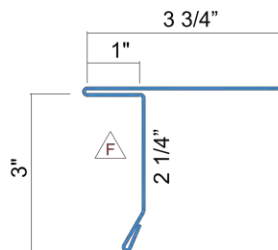

Extended Gable Trim, 3" Face

SS18

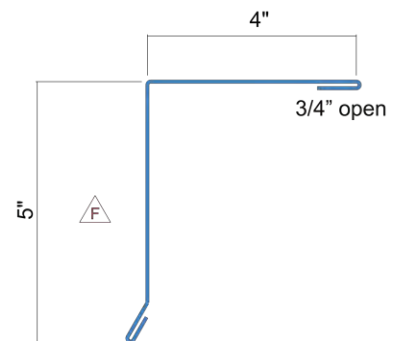

Box Gable Trim, 5" Face

Flashings and Trims

SS24

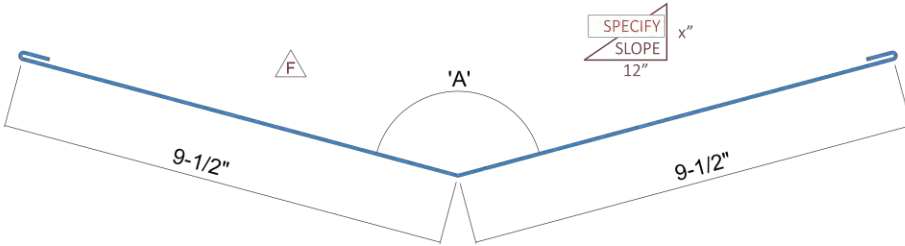

Valley Flashing

SS26

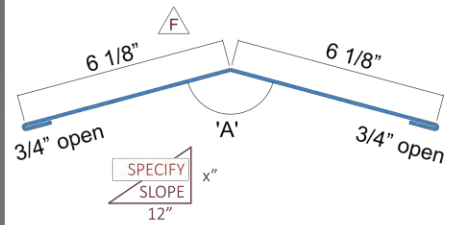

Ridge Flashing

SS25

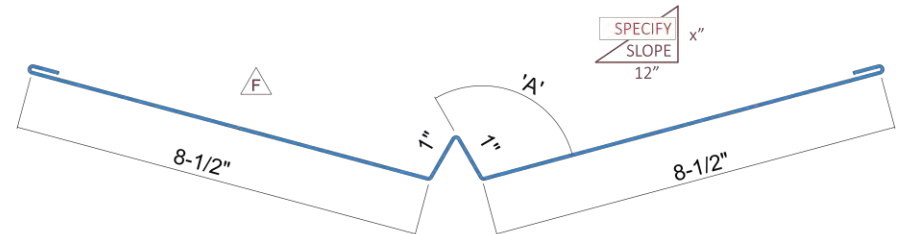

W-Valley Flashing

SS27

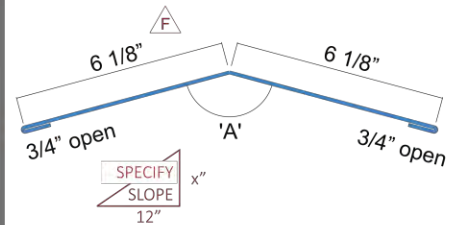

Hip Flashing

VR10

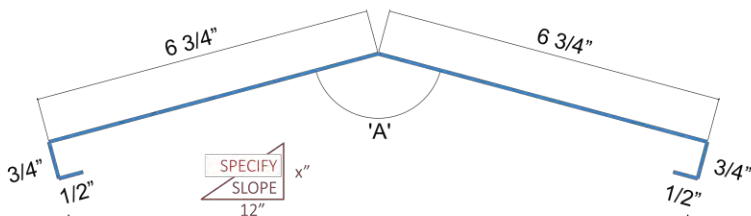

Vented Ridge Cover

SS19

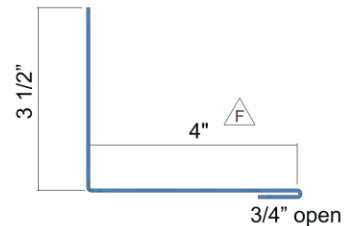

Sidewall Flashing

Flashings and Trims

SS20

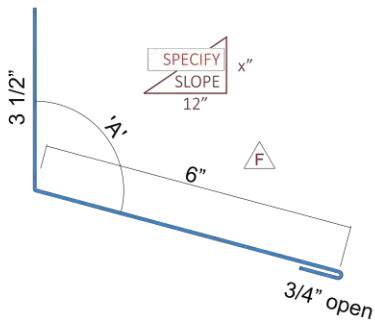

Highwall Flashing

SS21

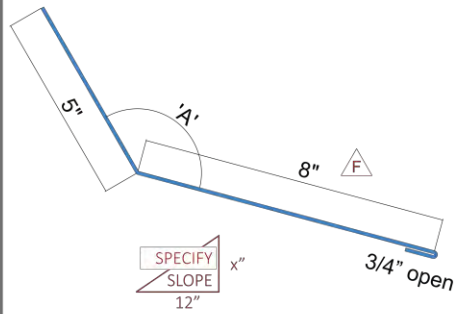

Slope Transition Flashing

SS23

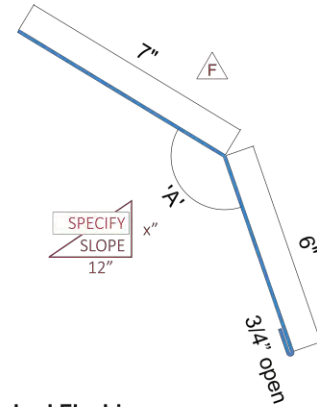

Gambrel Flashing

SS29

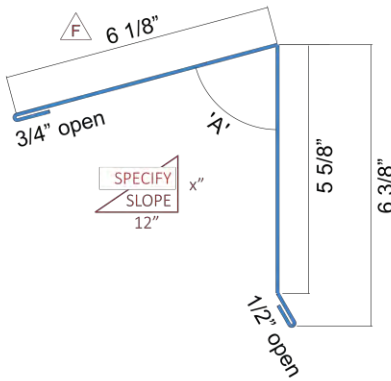

Peak Flashing

SS31

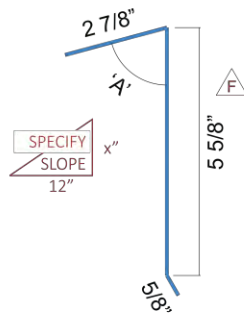

Pleak Flashing Cleat
Use with SS29 Peak Flashing

CL01

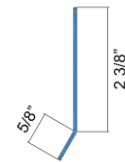

Standard Cleat

OC01

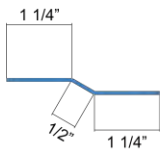

Offset Cleat

PC02

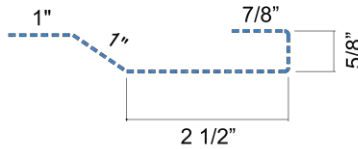

Perforated Vent Cleat (20 gauge)
Use with VR10 Ridge Cap

ZE11

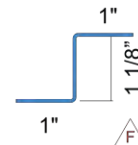

Zee Closure, 1 1/8" for Advantage-LokII

Flashings and Trims

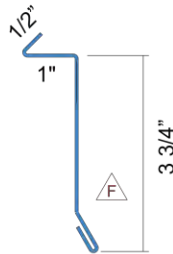
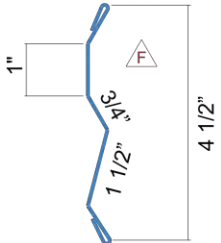
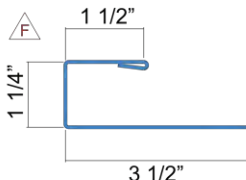
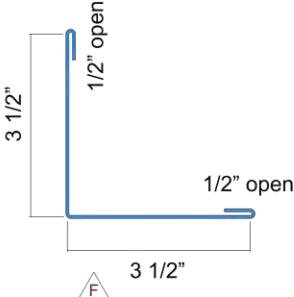
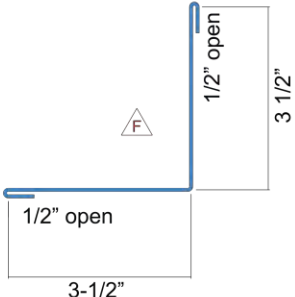
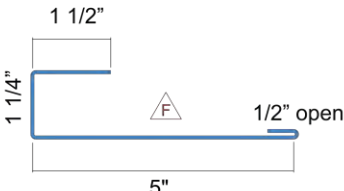
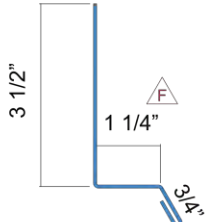
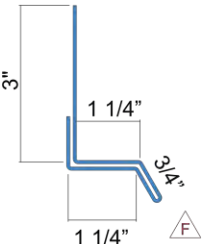
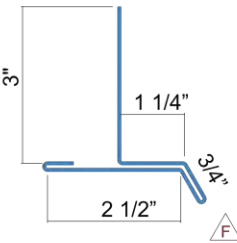
<p>SS36</p>  <p>Reglet Flashing</p>	<p>SS37</p>  <p>Surface Mounted Counter Flashing</p>	<p>SS34</p>  <p>J-Channel, 1 1/4" for Advantage-LokII</p>
<p>CN01</p>  <p>Outside Corner Trim</p>	<p>CN02</p>  <p>Inside Corner Trim</p>	<p>SS32</p>  <p>J-Channel, 1 1/4" for Advantage-LokII Use at specific sidewall and gable details</p>
<p>SL01</p>  <p>Sill Trim, 1 1/4" for Advantage-LokI</p>	<p>SL10</p>  <p>Sill Trim, 1 1/4" for Advantage-LokII</p>	<p>SL20</p>  <p>Sill Trim, 1 1/4" for Advantage-LokII</p>

Flashings and Trims

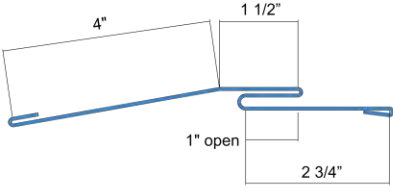
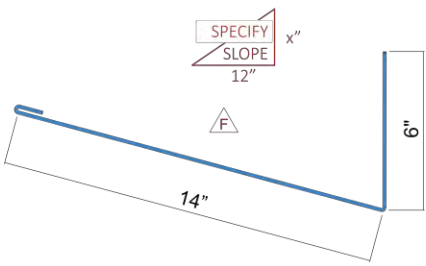
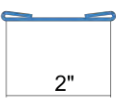
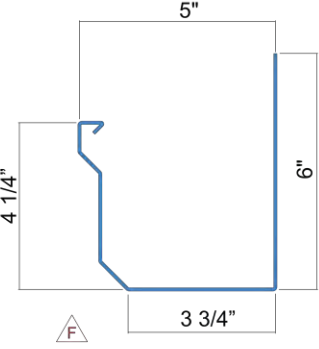
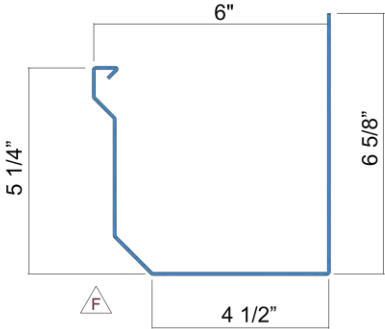
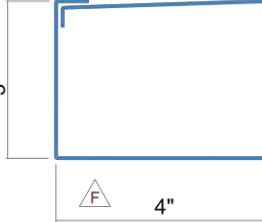
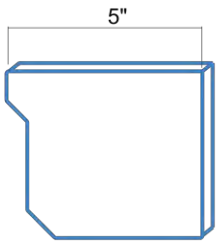
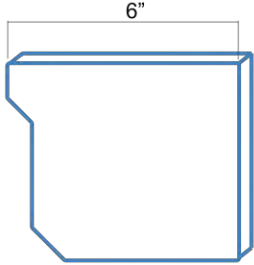
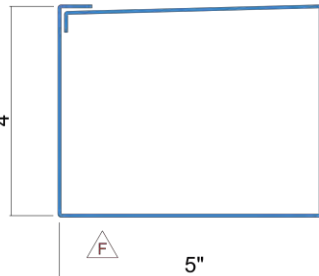
<p>SS22</p>  <p>Transition Flashing For starting panels over membrane roofing</p>	<p>LW02</p>  <p>Low Wall Flashing</p>	<p>DX01</p>  <p>Downspout Strapping Field cut from 10'-0" lengths</p>
<p>GT05</p>  <p>Gutter, 5" Style D, Straight Back</p>	<p>GT06</p>  <p>Gutter, 6" Style D, Straight Back</p>	<p>DS34</p>  <p>Downspout, 3" x 4" Rectangular</p>
<p>GT05L / GT05R</p>  <p>Gutter End Cap, 5" Specify left and right</p>	<p>GT06L / GT06R</p>  <p>Gutter End Cap, 6" Specify left and right</p>	<p>DS45</p>  <p>Downspout, 4" x 5" Rectangular</p>

Advantage-Lok II

Wood Substrate Details

Architectural / Solid Substrate / Steep Slope

The following details are commonly used with steep sloped applications including those over solid substrates such as plywood or steel decking with rigid insulation. Such details are largely based on hydrokinetic (water-shedding) design principles and architectural detailing.

(Refer to Advantage-LokII Master Detail Set for additional detailing options and instructions)

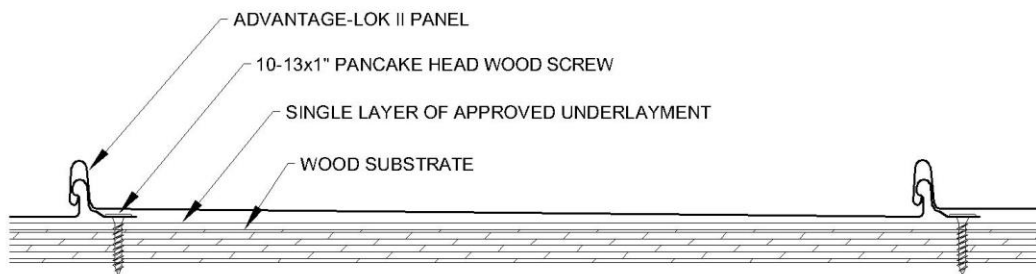

Eave Detail (up to 7:12 slope)

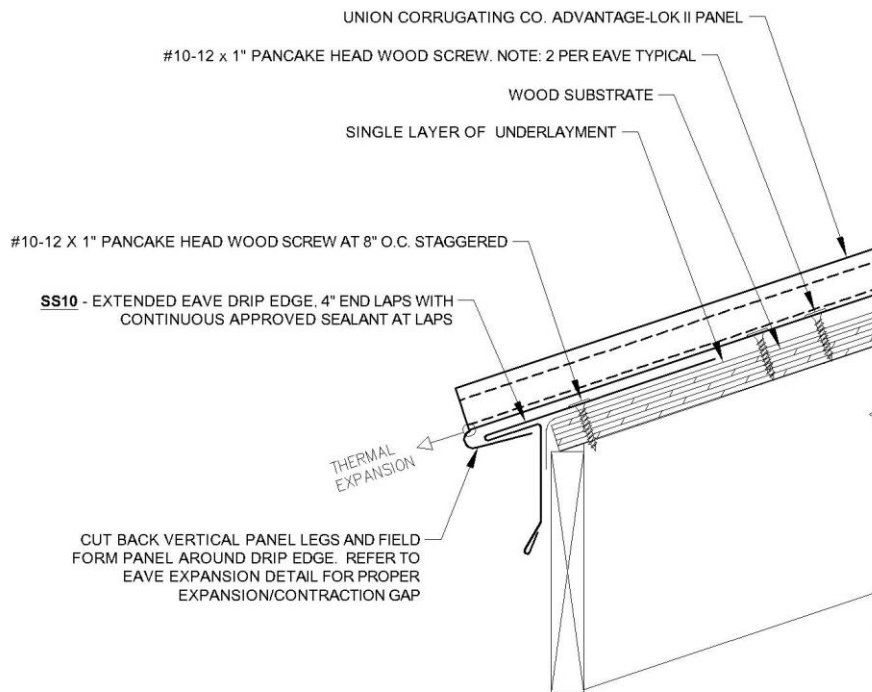

Eave Detail (steep slope)

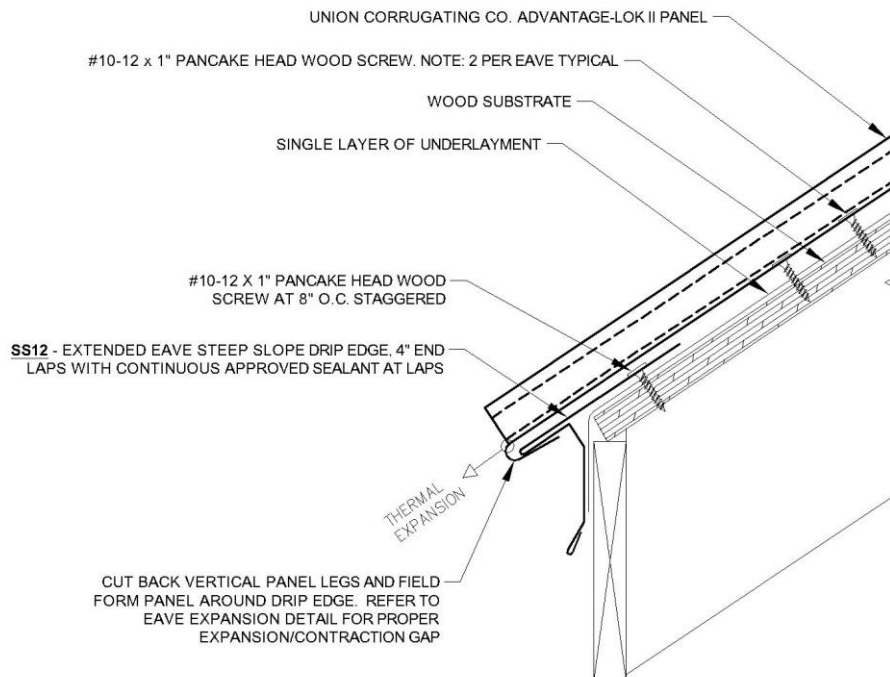

Eave Detail (flush style)

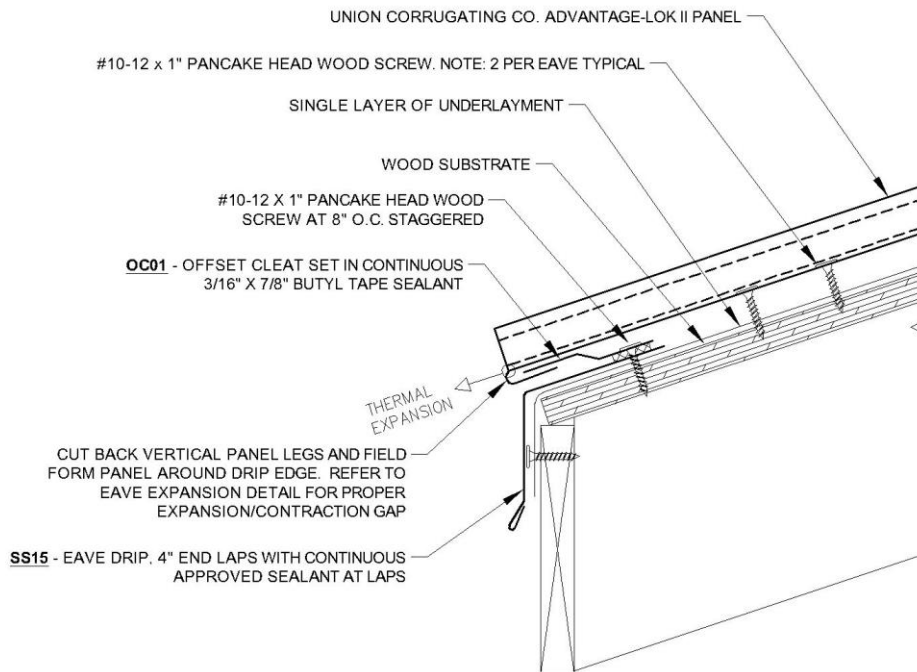

Eave Detail (with gutter)

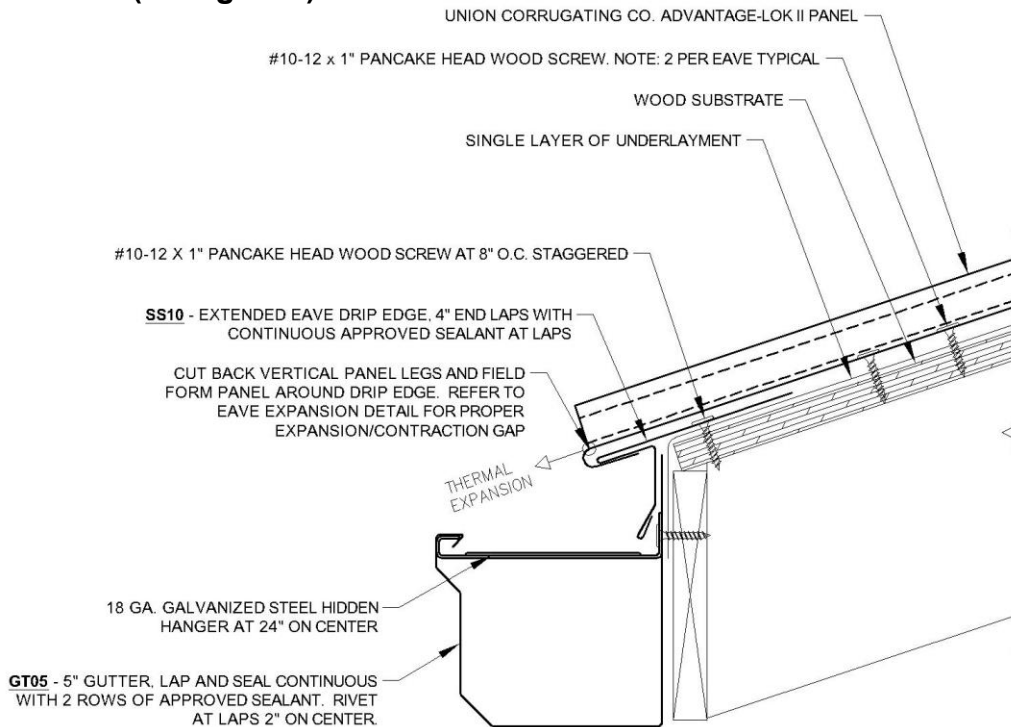

Gable Detail (extended drip edge style)

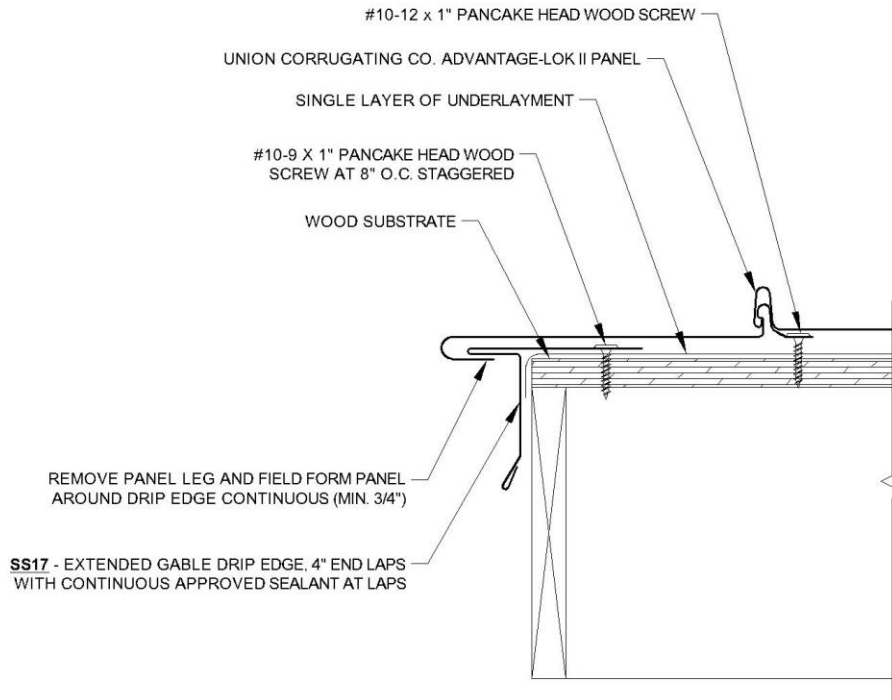

Gable Detail (box style with zee closure)

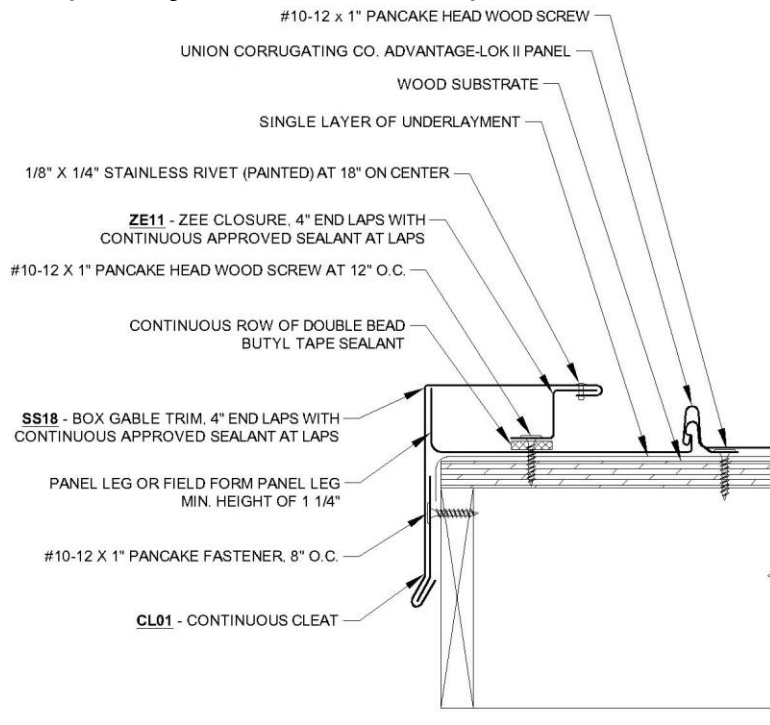

Valley Detail

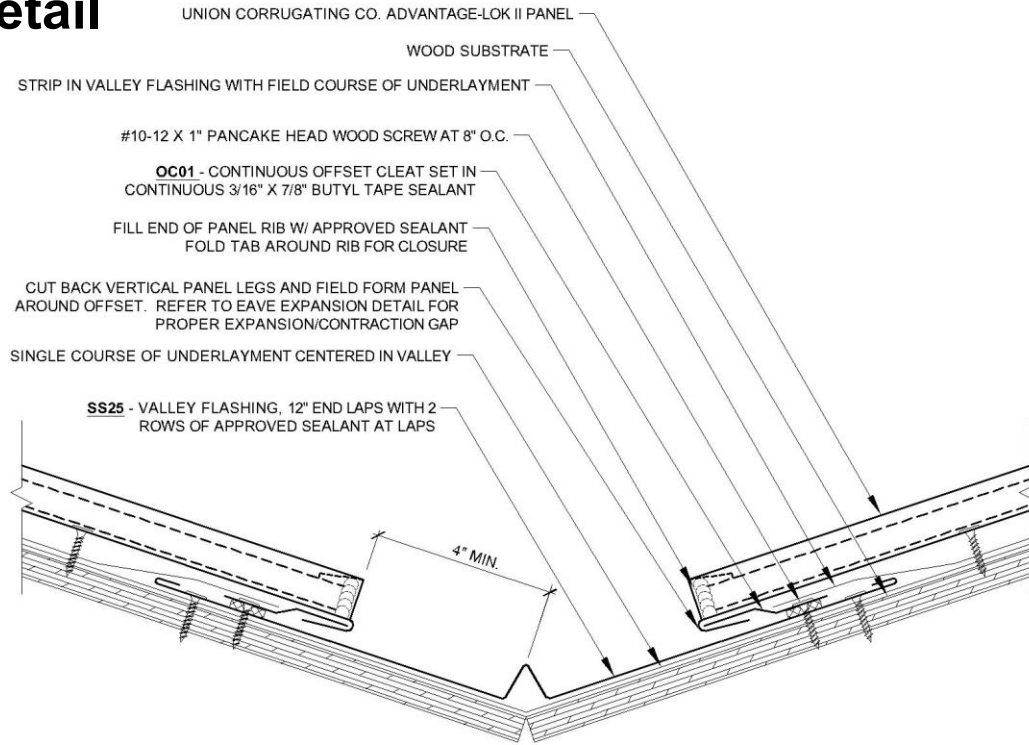

Ridge and Hip Detail

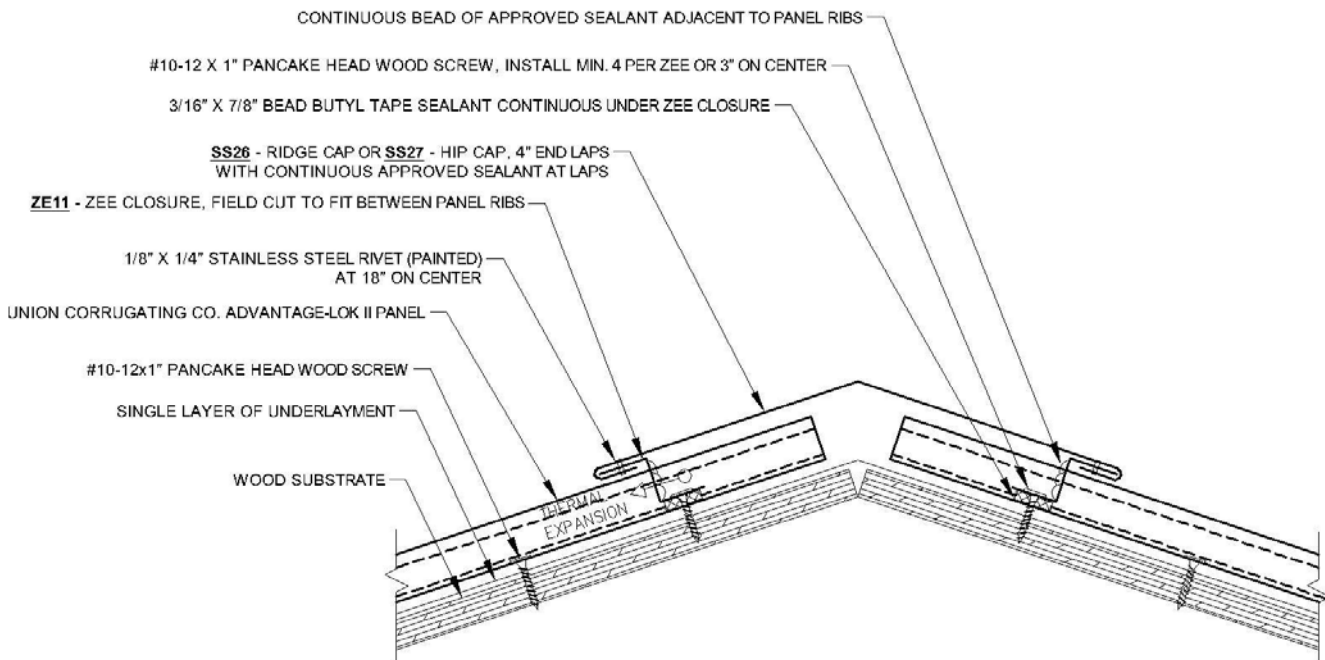

Vented Ridge Detail (with perforated cleat)

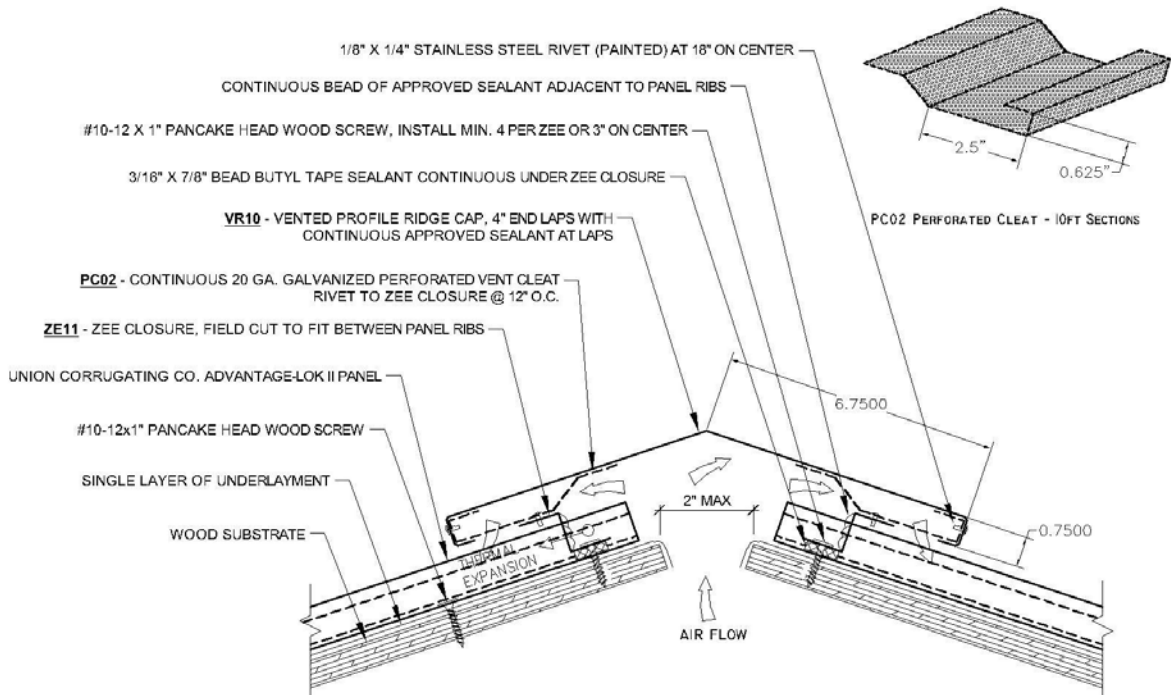

Vented Ridge Detail (with vented zee closure)

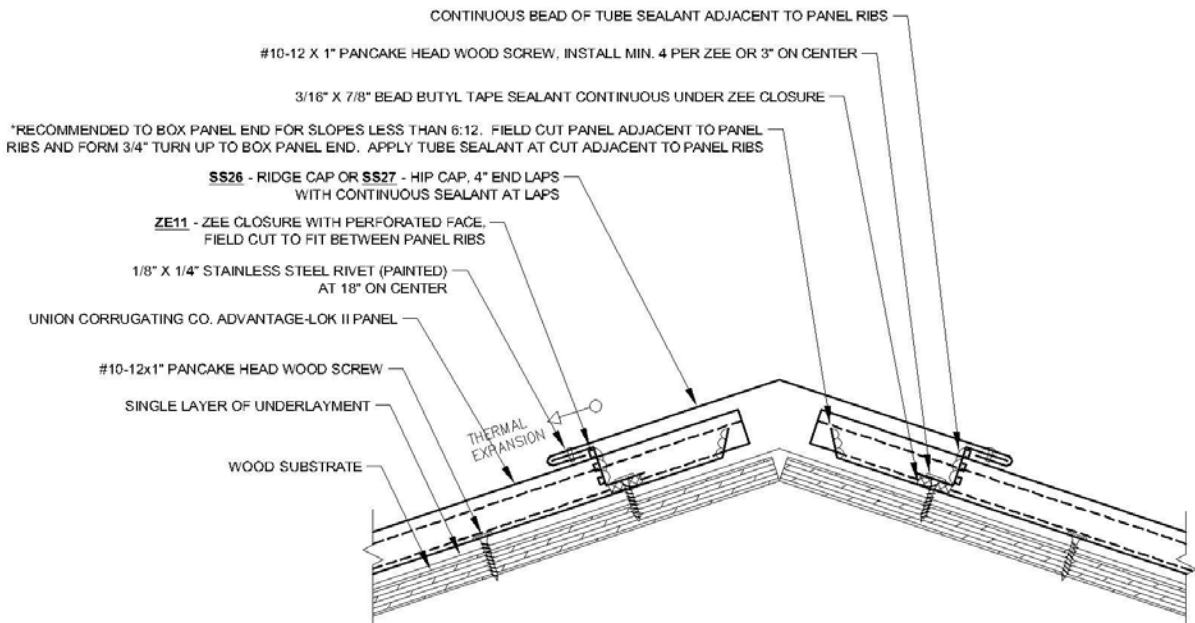

Peak Detail

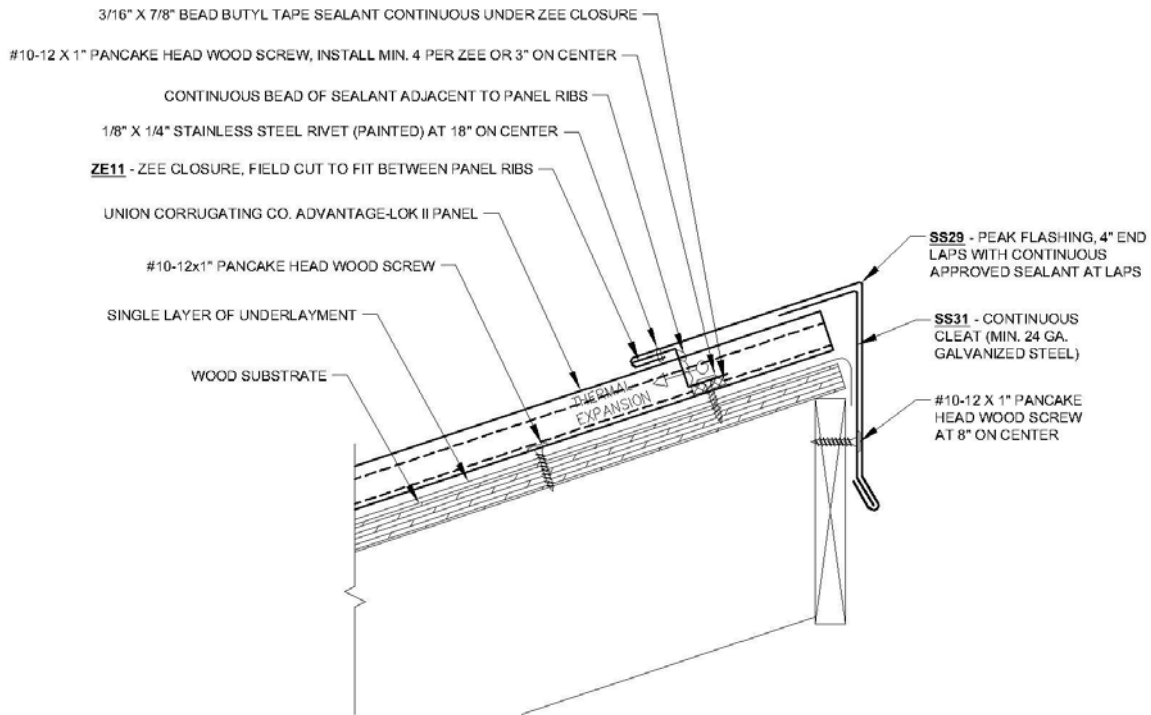

Highwall (Endwall) Detail

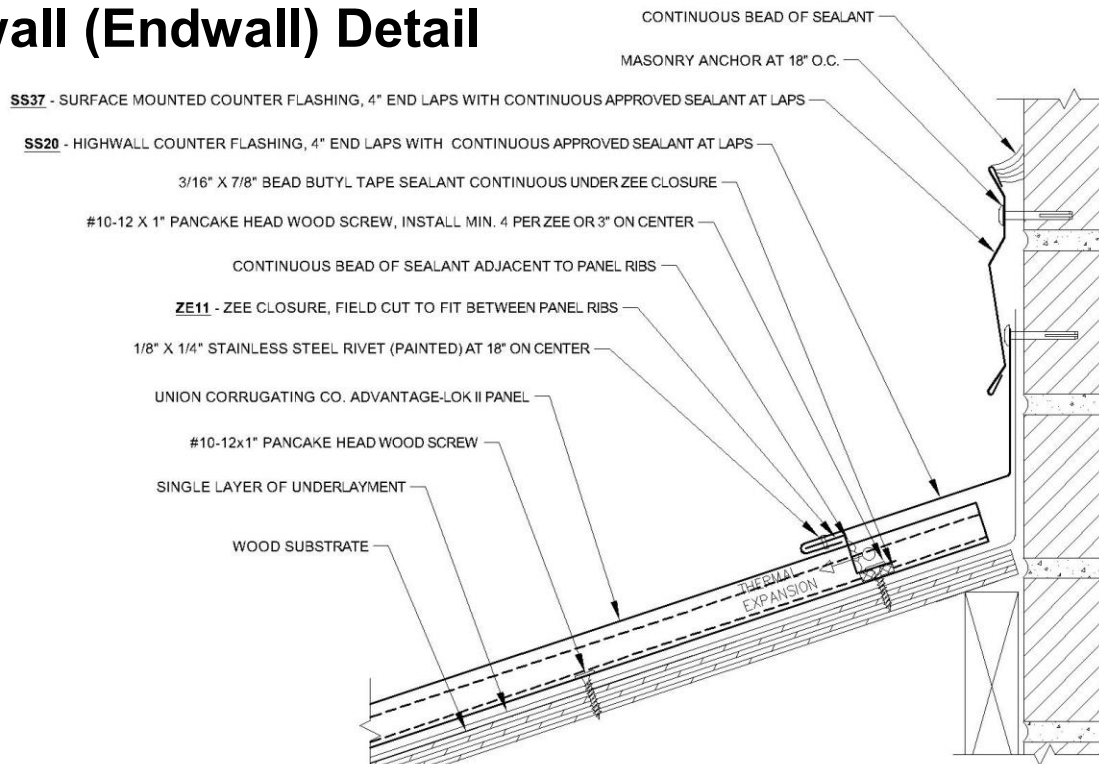

Low Wall Detail

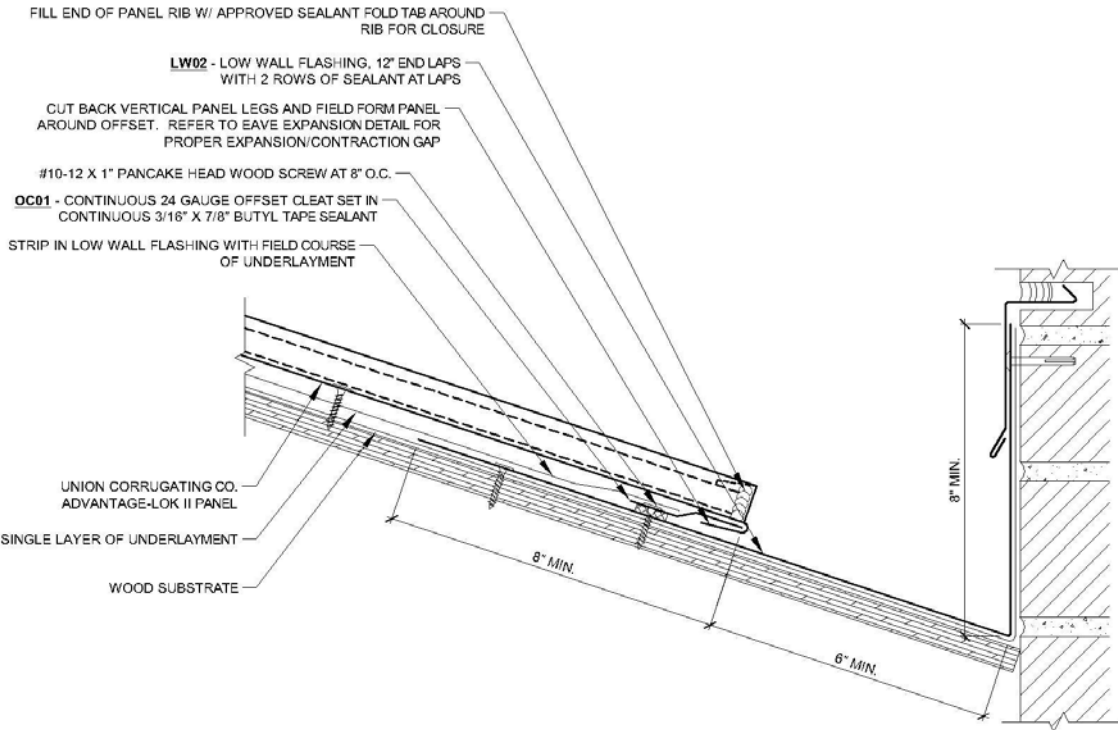

Sidewall Detail

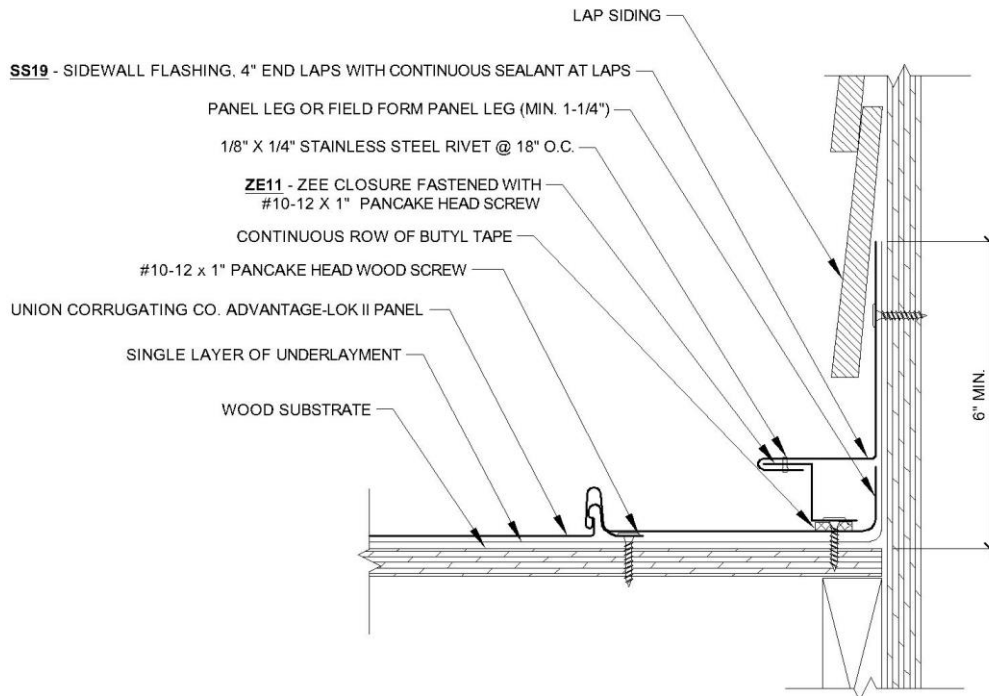

Slope Transition Detail

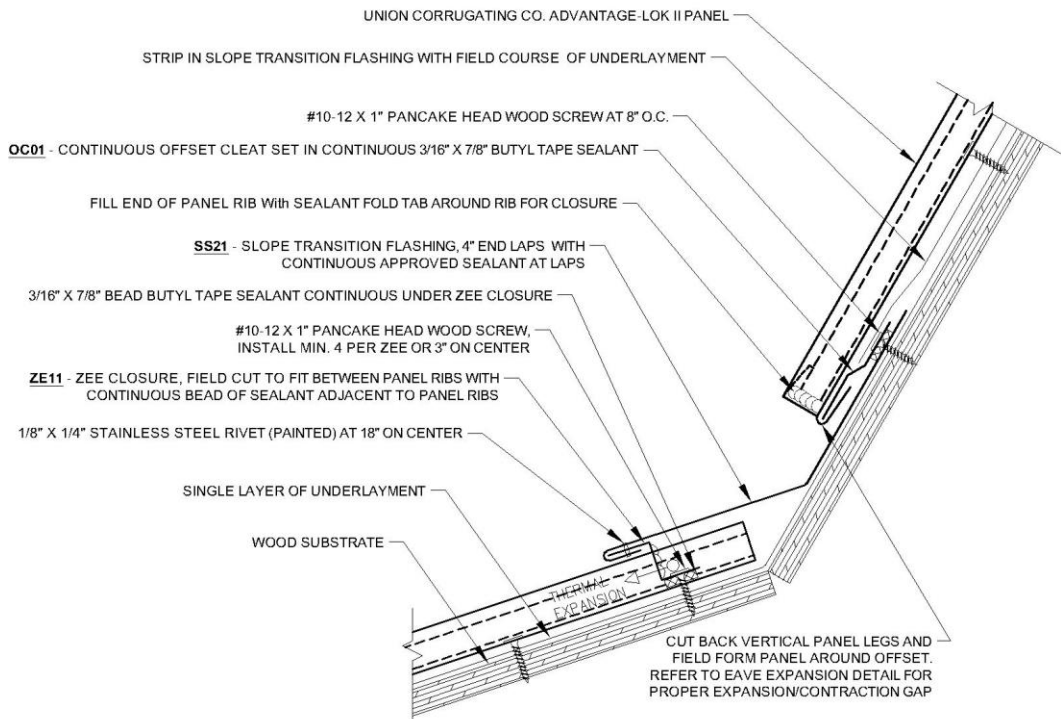

Gambrel Detail

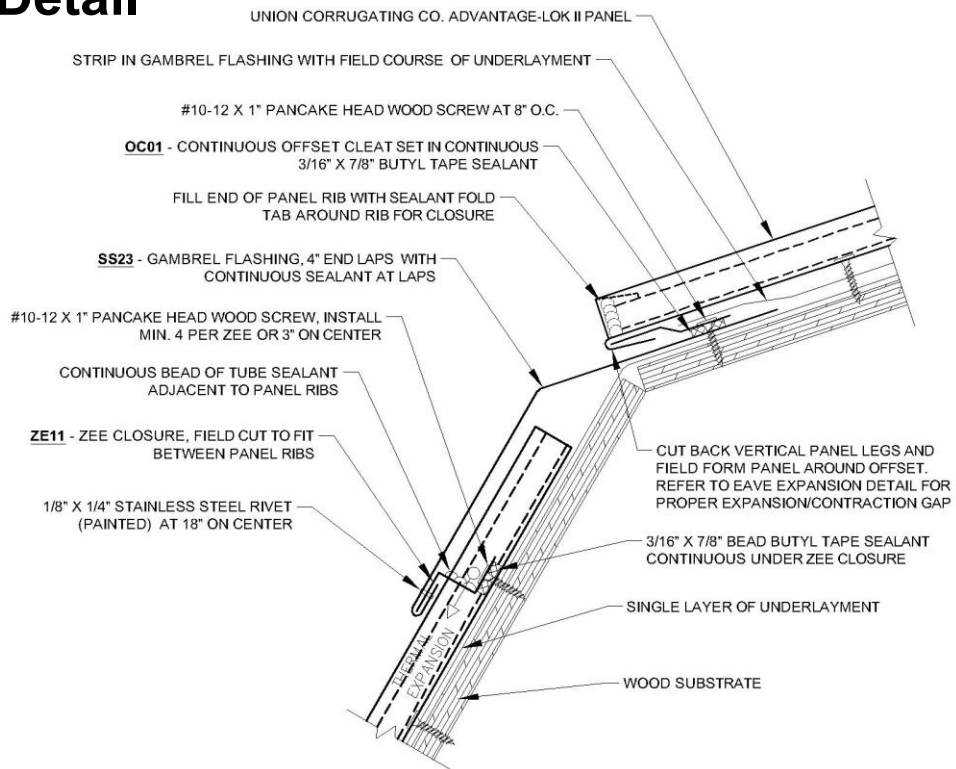

Pipe Penetration Detail

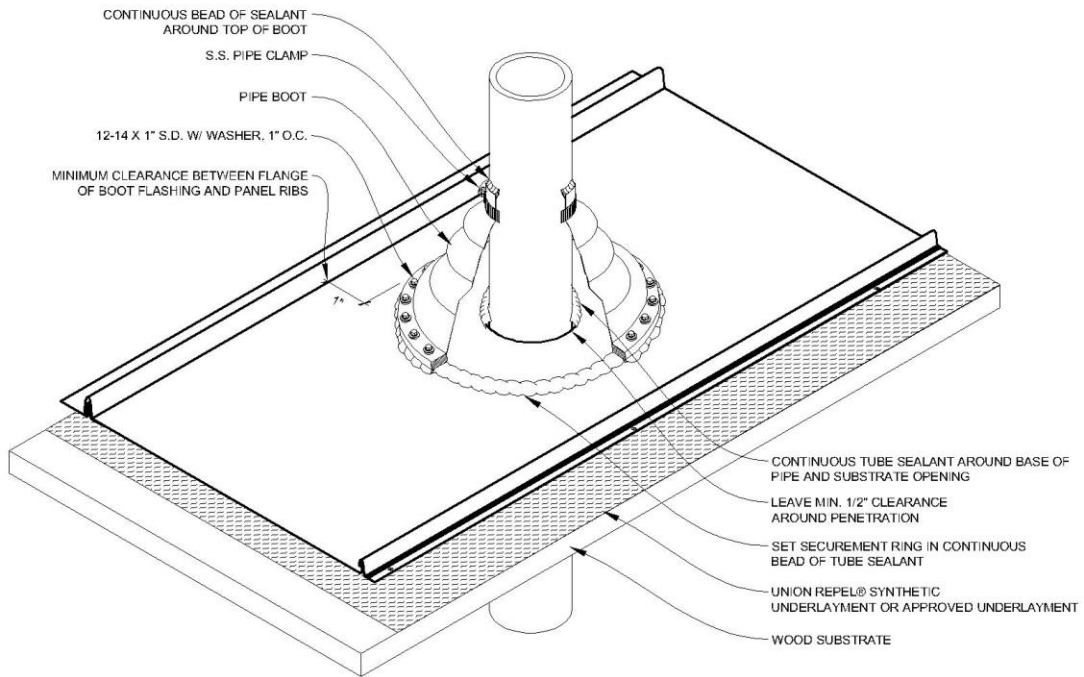

Curb Detail Series

Step 1 – Install panels around curb

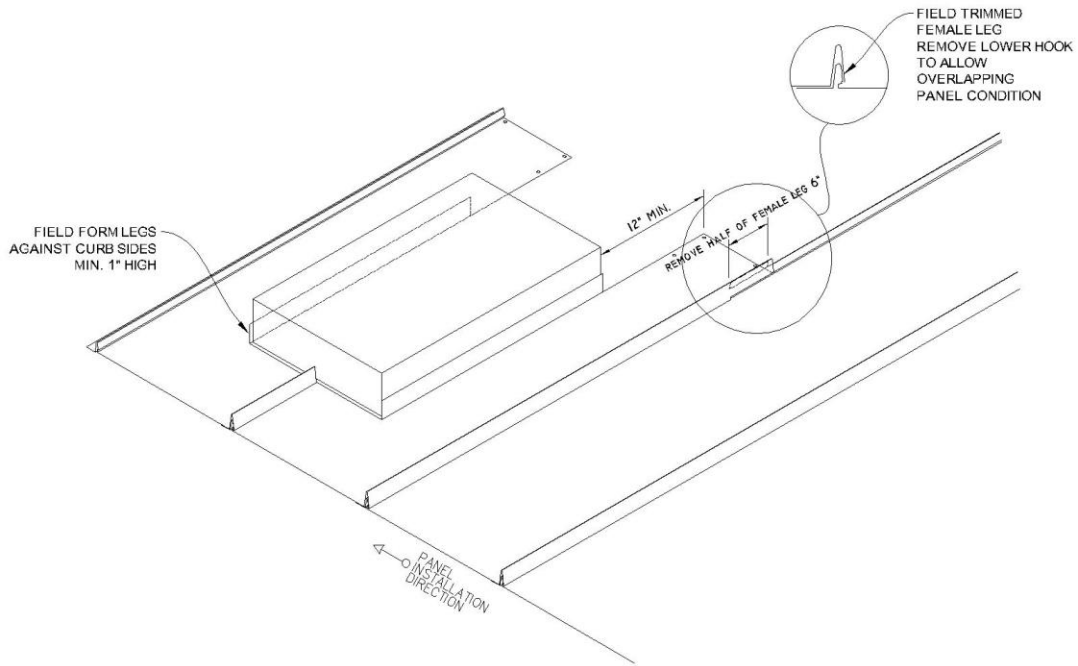

Step 2 – Install zee closures

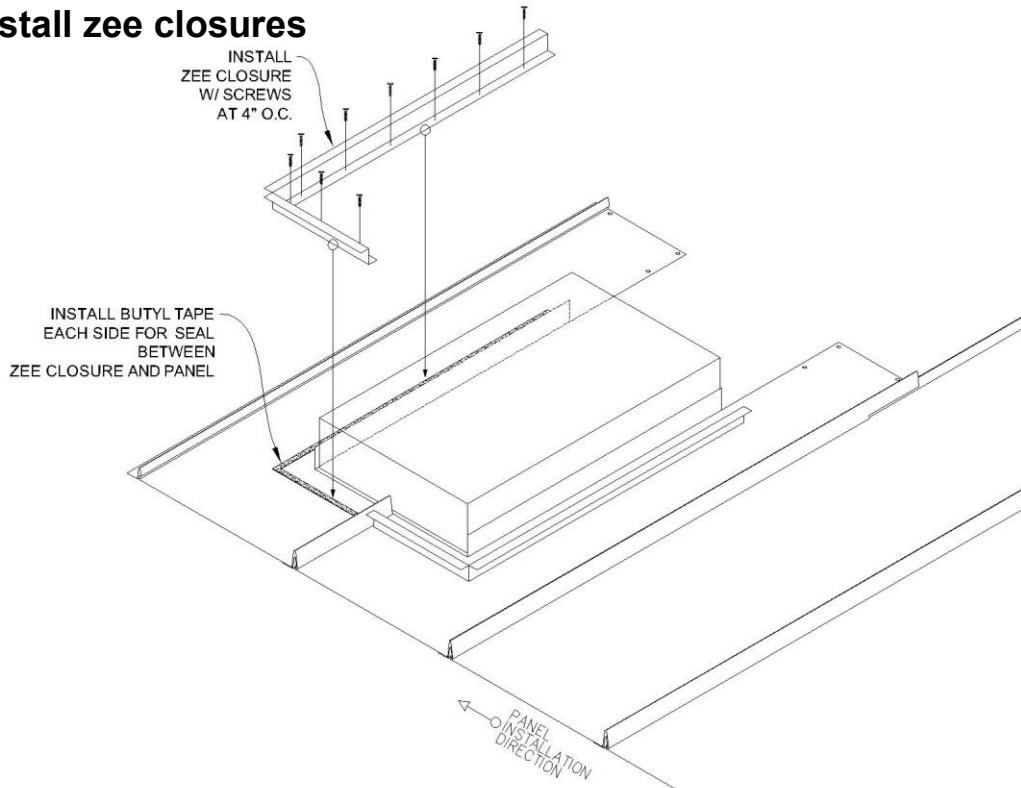

Step 3 – Install highwall and sidewall flashings

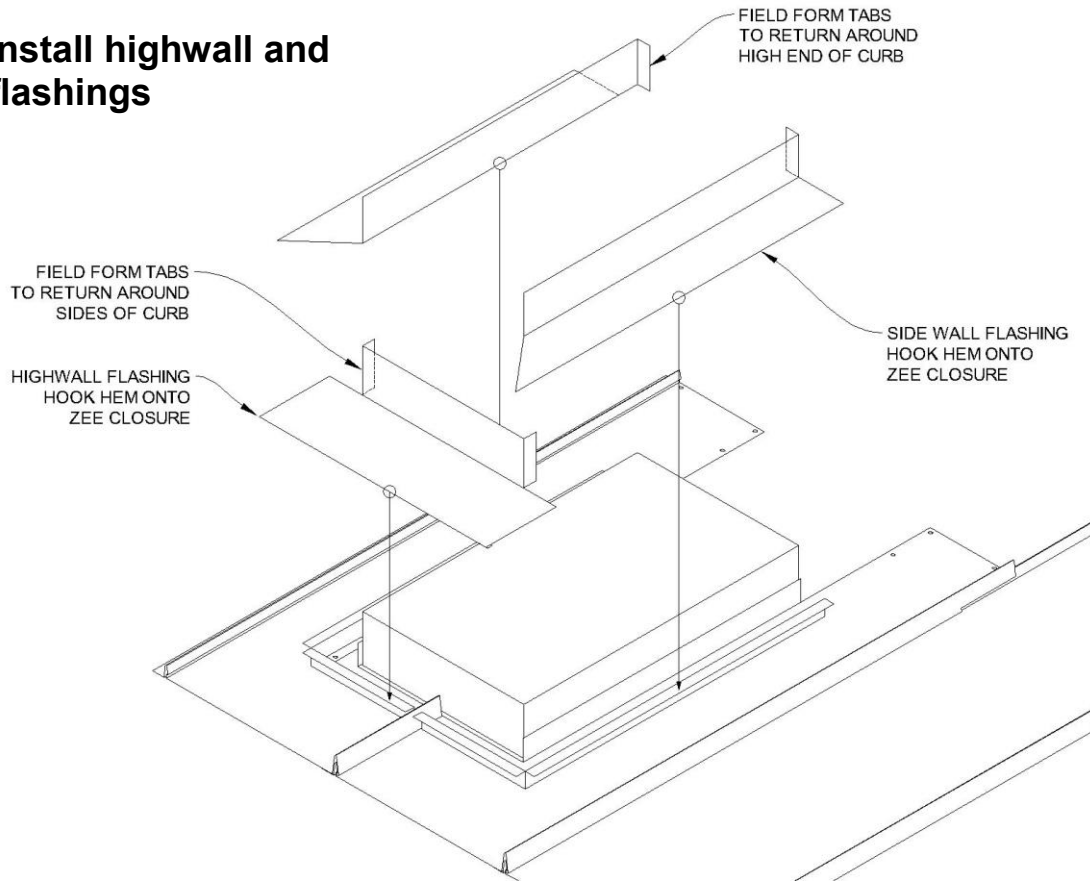

Step 4 – Low Wall Flashing

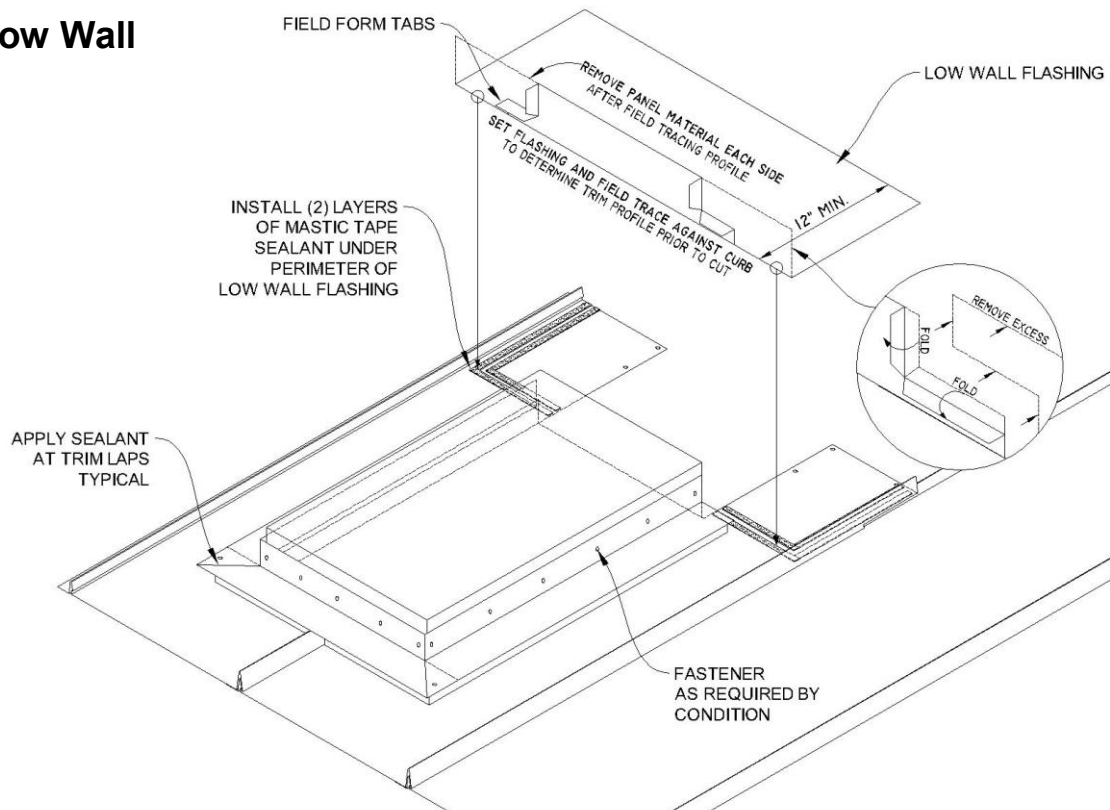

Step 5 – Install cleat and prepare for upper panel

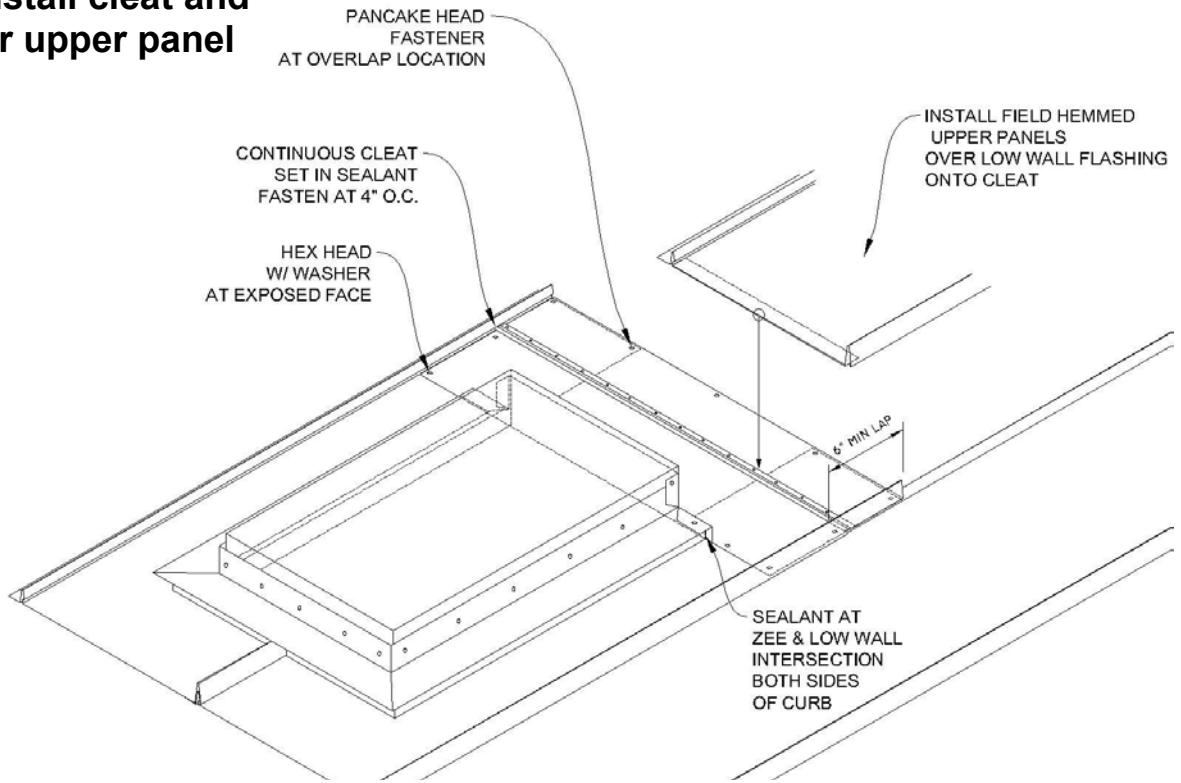

Step 6 – Complete upper panel installation

